



**SILENT
KNIGHT**

by Honeywell

Model SK-5208

Fire Control / Communicator

**Installation and
Operations Manual**

Document 151204

Rev: **P**

P/N 151204:P ECN: 17-0298

Installation Procedure

Adherence to the following will aid in problem-free installation with long-term reliability:

Installation Precautions - Adherence to the following will aid in problem-free installation with long-term reliability:

WARNING - Several different sources of power can be connected to the fire alarm control panel. Disconnect all sources of power before servicing. Control unit and associated equipment may be damaged by removing and/or inserting cards, modules, or interconnecting cables while the unit is energized. Do not attempt to install, service, or operate this unit until manuals are read and understood. **CAUTION** - System Re-acceptance Test after Software Changes: To ensure proper system operation, this product must be tested in accordance with NFPA 72 after any programming operation or change in site-specific software. Re-acceptance testing is required after any change, addition or deletion of system components, or after any modification, repair or adjustment to system hardware or wiring. All components, circuits, system operations, or software functions known to be affected by a change must be 100% tested. In addition, to ensure that other operations are not inadvertently affected, at least 10% of initiating devices that are not directly affected by the change, up to a maximum of 50 devices, must also be tested and proper system operation verified. This system meets NFPA requirements for operation within the range of 0°C-49°C (32°F-120°F) or humidity within the range of 10%-93% at 30°C (86°F) non-condensing. However, the useful life of the system's standby batteries and the electronic components may be adversely affected by extreme temperature ranges and humidity. Therefore, it is recommended that this system and its peripherals be installed in an environment with a normal room temperature of 15-27° C/60-80° F. **Verify that wire sizes are adequate** for all initiating and indicating device loops. Most devices cannot tolerate more than a 10% I.R. drop from the specified device voltage. **Like all solid state electronic devices**, this system may operate erratically or can be damaged when subjected to lightning induced transients. Although no system is completely immune from lightning transients and interference, proper grounding will reduce susceptibility. Overhead or outside aerial wiring is not recommended, due to an increased susceptibility to nearby lightning strikes. Consult with the Technical Services Department if any problems are anticipated or encountered. **Disconnect AC power and batteries** prior to removing or inserting circuit boards. Failure to do so can damage circuits. Remove all electronic assemblies prior to any drilling, filing, reaming, or punching of the enclosure. When possible, make all cable entries from the sides or rear. Before making modifications, verify that they will not interfere with battery, transformer, or printed circuit board location. **Do not tighten screw terminals** more than 9 in-lbs. Over-tightening may damage threads, resulting in reduced terminal contact pressure and difficulty with screw terminal removal. Fire alarm control panels contain static-sensitive components. Always ground yourself with a proper wrist strap before handling any circuits so that static charges are removed from the body. Use static suppressive packaging to protect electronic assemblies removed from the unit.

Follow the instructions in the installation, operating, and programming manuals. These instructions must be followed to avoid damage to the control panel and associated equipment. Fire Alarm Control Panel (FACP) operation and reliability depend upon proper installation.

While installing a fire alarm system may make lower insurance rates possible, it is not a substitute for fire insurance! **An automatic fire alarm system** - typically made up of smoke detectors, heat detectors, manual pull stations, audible warning devices, and a fire alarm control with remote notification capability - can provide early warning of a developing fire. Such a system, however, does not assure protection against property damage or loss of life resulting from a fire. **Any fire alarm system** may fail for a variety of reasons: Smoke detectors may not sense fire where smoke cannot reach the detectors such as in chimneys, in walls, or roofs, or on the other side of closed doors. **Smoke detectors** also may not sense a fire on another level or floor of a building. A second floor detector, for example, may not sense a first floor or basement fire. Furthermore, all types of smoke detectors, including ionization and photoelectric types, have sensing limitations. No type of smoke detector can sense every kind of fire caused by carelessness and safety hazards like smoking in bed, violent explosions, escaping gas, improper storage of flammable materials, overloaded electrical circuits, children playing with matches, or arson.

IMPORTANT! Smoke detectors must be installed in the same room as the control panel and in rooms used by the system for the connection of alarm transmission wiring, communications, signaling, and/or power. If detectors are not so located, a developing fire may damage the alarm system, crippling its ability to report a fire. **Audible warning devices** such as bells may not alert people if these devices are located on the other side of closed or partly open doors or are located on another floor of a building. **A fire alarm system** will not operate without any electrical power. If AC power fails, the system will operate from standby batteries only for a specified time. **Rate-of-Rise heat detectors** may be subject to reduced sensitivity over time. For this reason, the rate-of-rise feature of each detector should be tested at least once per year by a qualified fire protection specialist. **Equipment used in the system** may not be technically compatible with the control. It is essential to use only equipment listed for service with your control panel. **Telephone lines** needed to transmit alarm signals from a premise to a central monitoring station may be out of service or temporarily disabled. **The most common cause** of fire alarm malfunctions, however, is inadequate maintenance. All devices and system wiring should be tested and maintained by professional fire alarm installers following written procedures supplied with each device. System inspection and testing should be scheduled monthly or as required by national and/or local fire codes. Adequate written records of all inspections should be kept.

Contents

Section 1

Introduction 1-1

- 1.1 Model SK-5208 Features 1-1
- 1.2 About This Manual 1-1
- 1.3 How to Contact Silent Knight 1-1
 - 1.3.1 Optional Accessories 1-2

Section 2

Agency Listings and Requirements 2-1

- 2.1 Federal Communications Commission (FCC) 2-1
- 2.2 Underwriters Laboratories (UL) 2-1
 - 2.2.1 Requirements for All Installations 2-2
 - 2.2.2 Requirements for Central Station Fire Alarm Systems 2-2
 - 2.2.3 Requirements for Auxiliary Protected Fire Alarm Systems for Fire Alarm Service 2-2
 - 2.2.4 Requirements for Remote Station Protected Fire Alarm Systems, for Digital Communication or Polarity Reversal 2-2

Section 3

Control Panel Installation 3-1

- 3.1 Electrical Specifications 3-1
- 3.2 Environmental Specifications 3-1
- 3.3 Wiring Specifications 3-1
- 3.4 Control Board Components 3-3
- 3.5 Mounting the SK-5208 3-4
 - 3.5.1 Preventing Water Damage 3-4
- 3.6 Current Draw Calculations 3-4
 - 3.6.1 Worksheet Requirements 3-4
 - 3.6.2 Current Draw Worksheet 3-5
 - 3.6.3 Maximum Battery Standby Load 3-6
- 3.7 AC Wiring 3-6
- 3.8 Backup Batteries 3-7
- 3.9 Terminal Strip Description 3-8
- 3.10 Telephone Line Connection 3-10
- 3.11 Detector Installation 3-10
 - 3.11.1 Class A (Style D) Zones 3-10
 - 3.11.2 Class B (Style B) Zones 3-11
 - 3.11.3 Four-Wire Smoke Detector Connection 3-12
 - 3.11.4 Two-Wire Smoke Detector Connection 3-13
- 3.12 Supervised Notification Appliance Outputs 3-13
- 3.13 Auxiliary Relays 3-15
- 3.14 Accessory Devices 3-15
 - 3.14.1 Setting ID Codes 3-15

3.14.2 Model SK-5235 Remote Annunciator	3-16
3.14.2.1 Mounting the SK-5235 Remote Annunciator	3-16
3.14.2.2 Wiring the SK-5235	3-17
3.14.3 Model SK-5280 Status Display Module	3-18
3.14.3.1 Mounting the SK-5280	3-19
3.14.3.2 Wiring Relays	3-20
3.14.3.3 Wiring LEDs to Outputs	3-21
3.14.4 Model SK-5217 Zone Expander Installation	3-22
3.14.4.1 Zone Inputs	3-22
3.14.4.2 Mounting Instructions	3-24
3.14.5 Model 5824 Installation Instructions	3-25
3.14.5.1 Mounting the 5824 Module	3-25
3.14.5.2 5824 SBUS Connections	3-26
3.15 Special Applications	3-27
3.15.1 Model 5220 Direct Connect Module	3-27
3.15.1.1 City Box Connection	3-27
3.15.1.2 NFPA 72 Polarity Reversal	3-28
3.15.2 Keltron 95M3158 Tones Transmitter Module	3-29
3.15.3 Using a MR-201/T Control Relay From Air Products	3-30

Section 4

Programming 4-1

4.1 Keypad Operation During Programming	4-1
4.1.1 Special Characters	4-2
4.1.2 Enabling Extended Programming List	4-2
4.2 Programming Flow	4-3
4.2.1 Zone Options	4-4
4.2.2 Misc System Option	4-5
4.2.3 NAC Cadence	4-6
4.2.3.1 Cadence Patterns	4-6
4.2.4 NAC Options	4-7
4.2.5 Relay Options	4-8
4.2.6 User Code	4-9
4.2.7 Account	4-10
4.2.8 Computer Options	4-11
4.2.8.1 Computer Code	4-11
4.2.9 Line Options	4-12
4.2.10 Misc Reporting	4-13
4.2.11 5280 Outputs	4-14
4.2.12 5824 Expander Options	4-15
4.2.13 DST/Clk Options	4-16
4.3 Programming Options	4-17

Section 5

Operation 5-1

5.1 Installer & User Keys	5-1
5.2 On-board Touchpad and SK-5235 Operation	5-2
5.2.1 View Control Panel Firmware Number and Revision	5-2
5.3 Acknowledge Operation	5-3

5.4	LED Indicators	5-3
5.5	Releasing Operation	5-4
5.5.1	Cross Alarm Operation	5-4
5.5.1.1	Default NAC Settings for Releasing	5-4
5.5.2	Double Interlock Releasing Operation	5-6
5.6	Smoke Alarm Verification	5-6
5.7	System Testing	5-7
5.7.1	Fire Drills	5-7
5.7.2	Walk Test	5-7
5.7.3	Automatic Self Test	5-7
5.7.4	Watchdog Circuit	5-7
5.8	Communicating with a Programming Computer	5-7
5.8.1	Programming From a Remote Computer Location	5-8
5.8.1.1	Having the Control Panel Call the Remote Computer	5-8
5.8.1.2	Having Remote Computer Call the Control Panel	5-8
5.8.2	Directly Connecting to a Programming Computer	5-9

Section 6
Reporting 6-1

6.1	Reporting Formats	6-1
6.2	Reporting Codes	6-2
6.2.1	Default Settings for 3/1 Format	6-5

Section 7
Troubleshooting 7-1

7.1	System Error Messages	7-1
7.2	Earth Ground Fault Troubleshooting	7-2
7.3	Earth Fault Resistance	7-3

Appendix A
Compatible Devices A-1

Silent Knight Fire Product Warranty and Return Policy
Manufacturer Warranties and Limitation of Liability
Model SK5208 Basic Operating Instructions

Section 1

Introduction

The Model SK-5208 is an 24-volt 10-zone fire alarm control panel (expandable up to 30 zones using SK-5217 Zone Expanders) with a digital communicator that meets NFPA 72 requirements. The SK-5208 cabinet can be surface mounted or semi-flush mounted.

1.1 Model SK-5208 Features

- Built-in two-line (16 Character each line) LCD display provides easy to read English language readouts
- 10 Initiation inputs, 8 Class B (Style B) and 2 zones that can be configured as Class B (Style B) or Class A (Style D), expandable to 30 zones
- Supervised zone expanders and I/O modules can be mounted remotely from the main control panel
- UL Listed
- Event History Buffer (approximately 150 events) with Date/Time stamp
- All zones are compatible with 2- and 4-wire detectors
- 8 selectable/programmable output pattern for notification appliance circuits (Including ANSI 3.41)
- Built-in Digital Alarm Communicator Transmitter (DACT)
- 4 Notification appliance circuits
- 4 programmable general purpose relays
- Programmable smoke verification, pre-alarm delay, cross zoning and enhanced verification mode features that can help minimize false alarms
- Capable of single or dual operation for water releasing services.
- Programmable from the built-in control panel touchpad, remote annunciator or Windows® downloading software
- Built-in walk test

1.2 About This Manual

This manual is intended to be a complete reference for all installation and operation tasks for the SK-5208. Please let us know if the manual does not meet your needs in any way. We value your feedback!

1.3 How to Contact Silent Knight

If you have a question or encounter a problem not covered in this manual, contact Silent Knight Technical Support at 800-446-6444.

To order parts, contact Silent Knight Sales at 800-328-0103.

1.3.1 Optional Accessories

Table 1-1: Compatible Modules Manufactured by Silent Knight

Model	What It Does
SK-5217 Zone Expander	Adds 10 zones to the SK-5208 for a total expansion of the system to 30 zones.
SK-2190 Accessory Cabinet	Used for remote mounting of the SK-5217 Zone Expander. Dimensions: 10-3/8"W x 10-3/16"H x 3"D (26.35 cm W x 25.88 cm H x 7.62 cm D)
5220 Direct Connect Module	For direct alarming and trouble transmission from the SK-5208 to a supervising station.
SK-5235 Remote Annunciator	For remote annunciation, operation, and on-site programming.
SK-5280	The Model SK-5280 Status Display module provides outputs and control functions for remote annunciation of alarm, trouble, and supervisories for each zone.
5824	Provides connectivity to a Serial or Parallel printer. (See Section 4.2.12 for programming.)
SK-5499 Signal Power Expander	Notification circuit power for additional notification appliances. Provides additional 9A of 24 VDC, supervised.
SK-5495 Signal Power Expander	Notification circuit power for additional notification appliances. Provides additional 6A of 24 VDC, supervised.
SKSS Downloading Software Model 5660	For remote programming of the SK-5208 using a personal computer.
PLEX-2	Optional door accessory for single button operation. (See Section 4.3 for programming.)

Limitations of Fire Alarm Systems

Manufacturer recommends that smoke and/or heat detectors be located throughout a protected premise following the recommendations of the current edition of the National Fire Protection Association Standard 72 (NFPA 72), manufacturer's recommendations, State and local codes, and the recommendations contained in Guide for the Proper Use of System Smoke Detectors, which is made available at no charge to all installing dealers. A study by the Federal Emergency Management Agency (an agency of the United States government) indicated that smoke detectors may not go off or give early warning in as many as 35% of all fires. While fire alarm systems are designed to provide warning against fire, they do not guarantee warning or protection against fire. A fire alarm system may not provide timely or adequate warning, or simply may not function, for a variety of reasons. For example:

- Particles of combustion or smoke from a developing fire may not reach the sensing chambers of smoke detectors because:
 - Barriers such as closed or partially closed doors, walls, or chimneys may inhibit particle or smoke flow.
 - Smoke particles may become cold, stratify, and not reach the ceiling or upper walls where detectors are located.
 - Smoke particles may be blown away from detectors by air outlets
 - Smoke particles may be drawn into air returns before reaching the detector.

In general, smoke detectors on one level of a structure cannot be expected to sense fires developing on another level.

- The amount of smoke present may be insufficient to alarm smoke detectors. Smoke detectors are designed to alarm at various levels of smoke density. If such density levels are not created by a developing fire at the location of detectors, the detectors will not go into alarm.
- Smoke detectors, even when working properly, have sensing limitations. Detectors that have photoelectronic sensing chambers tend to detect smoldering fires better than flaming fires, which have little visible smoke. Detectors that have ionizing-type sensing chambers tend to detect fast flaming fires better than smoldering

fires. Because fires develop in different ways and are often unpredictable in their growth, neither type of detector is necessarily best and a given type of detector may not provide adequate warning of a fire.

- Smoke detectors are subject to false alarms and nuisance alarms and may have been disconnected by users. For example, a smoke detector located in or near a kitchen may go into nuisance alarm during normal operation of kitchen appliances. In addition, dusty or steamy environments may cause a smoke detector to falsely alarm. If the location of a smoke detector causes an abundance of false alarms or nuisance alarms, do not disconnect the smoke detector; call a professional to analyze the situation and recommend a solution.
- Smoke detectors cannot be expected to provide adequate warning of fires caused by arson, children playing with matches (especially within bedrooms), smoking in bed, violent explosions (caused by escaping gas, improper storage of flammable materials, etc.).
- Heat detectors do not sense particles of combustion and are designed to alarm only when heat on their sensors increases at a predetermined rate or reaches a predetermined level. Heat detectors are designed to protect property, not life.
- Warning devices (including horns, sirens, and bells) may not alert people or wake up sleepers who are located on the other side of closed or partially open doors. A warning device that activates on a different floor or level of a dwelling or structure is less likely to awaken or alert people. Even persons who are awake may not notice the warning if the alarm is muffled by noise from a stereo, radio, air conditioner or other appliance, or by passing traffic. Audible warning devices may not alert the hearing-impaired (strobes or other devices should be provided to warn these people). Any warning device may fail to alert people with a disability, deep sleepers, people who have recently used alcohol or drugs, or people on medication or sleeping pills.
- Please note that:
 - i) Strobes can, under certain circumstances, cause seizures in people with conditions such as epilepsy.
 - ii) Studies have shown that certain people, even when they hear a fire alarm signal, do not respond or comprehend the meaning of the signal. It is the property owner's responsibility to conduct fire drills and other training exercises to make people aware of fire alarm signals and instruct on the proper reaction to alarm signals.
 - iii) In rare instances, the sounding of a warning device can cause temporary or permanent hearing loss.
- Telephone lines needed to transmit alarm signals from a premises to a central station may be out of service or temporarily out of service. For added protection against telephone line failure, backup radio transmission systems are recommended.
- System components, though designed to last many years, can fail at any time. As a precautionary measure, it is recommended that smoke detectors be checked, maintained, and replaced per manufacturer's recommendations.
- System components will not work without electrical power. If system batteries are not serviced or replaced regularly, they may not provide battery backup when AC power fails.
- Environments with high air velocity or that are dusty or dirty require more frequent maintenance.

In general, fire alarm systems and devices will not work without power and will not function properly unless they are maintained and tested regularly.

While installing a fire alarm system may make the owner eligible for a lower insurance rate, an alarm system is not a substitute for insurance. Property owners should continue to act prudently in protecting the premises and the people in their premises and should properly insure life and property and buy sufficient amounts of liability insurance to meet their needs.

Section 2

Agency Listings and Requirements

Install and maintain in accordance with NFPA 72. Detector spacing shall be in accordance to NFPA 72. End-of-line relays and resistors shall be placed within the electrical box located and the end of the initiating circuit. Testing and maintenance should be performed according to NFPA 72.

2.1 Federal Communications Commission (FCC)

1. If requested by the telephone company, the following information must be provided before the SK-5208 can be connected to the phone lines:

A.	Manufacturer:	Silent Knight
A.	Model Number:	SK-5208
B.	FCC registration number:	AC6USA-34758-AL-E
	Ringer equivalence:	0.5B
C.	Type of jack (to be installed by the telephone company):	RJ31X

2. This device may not be directly connected to coin telephone or party line services.
3. This device cannot be adjusted or repaired in the field. In case of trouble with the device, notify the installing company or return to:
 Silent Knight
 12 Clintonville Road
 Northford, CT 06472-1610
 203-484-7161 or 800-328-0103
4. If the SK-5208 causes harm to the telephone network, the telephone company will notify the user in advance that temporary discontinuance of service may be required. When advance notice is not practical, the telephone company will notify the user as soon as possible. Users have the right to file complaints, if necessary, with the Federal Communications Commission.
5. The telephone company may make changes in its facilities, equipment, operations, or procedures that could affect the operation of the equipment. If this happens, the telephone company will provide advance notice to allow you to make the necessary modifications to maintain uninterrupted service.

Warning

This device has been verified to comply with FCC Rules Part 15. Operation is subject to the two following conditions: (1) This device may not cause radio interference; and (2) This device must accept any interference received including interference that may cause undesired operation.

2.2 Underwriters Laboratories (UL)

The SK-5208 is UL Listed as a control unit for use in Central Station Protected Premises, Local Protected Fire Alarm Systems, Auxiliary Protected Fire Alarm Systems for Fire Alarm Service (City Box), Remote Station Protected Fire Alarm Systems and water releasing service. If the SK-5208 and its accessories are to be used as part of a UL installation, carefully read the UL requirements in this section.

2.2.1 Requirements for All Installations

General requirements are described below. The sections that follow describe additional requirements for the type of installation (for example, Central Station Fire Alarm systems, Local Protected Fire Alarm systems, and so on).

1. Use UL listed smoke detectors compatible with the SK-5208. Refer to Appendix A.
2. Use UL listed compatible notification devices. Refer to Appendix A.

Restricted Options:

- The loss of AC signal is defaulted to 3 hours however the system allows settings from 0 - 30 hours. For UL certified installations this number must be set from 1 to 3 hours.
- Call forwarding shall not be used.
- When cross zoning is used detector spacing shall be cut in half, you shall not use the alarm verification feature, and no delay shall be used.

2.2.2 Requirements for Central Station Fire Alarm Systems

1. The Phone Line “Line Dial Type” must be selected for anything other than “Not Used”. (See programming Section 4.2.9).
2. On class A (style D) zones, the number of waterflow devices is limited to five.
3. Auxiliary relays may not be programmed to activate for Pre-Alarm. See programming Section 4.2.5.

2.2.3 Requirements for Auxiliary Protected Fire Alarm Systems for Fire Alarm Service

1. Follow the current load restrictions shown in Section 3.6.
2. The Model 5220 Direct Connect module must be installed (see Section 3.15.1 for wiring).

2.2.4 Requirements for Remote Station Protected Fire Alarm Systems, for Digital Communication or Polarity Reversal

1. Follow the current load restrictions shown in Section 3.6.
2. Use the SK-5208’s built-in dialer or install the Model 5220 Direct Connect Module (see Section 3.15.1).

Section 3

Control Panel Installation

3.1 Electrical Specifications

Table 3-1: Electrical Specifications

Primary AC	120 Vrms at 60 Hz, 3A
Total DC Load	6A
Accessory Power	27.4 VDC, 1A
Smoke Power	27.4 VDC, 1A
Battery Charging Voltage	27.4
Battery Charging Current	.75 A max.
Class B (Style B) Circuit Current	95 mA max.
Telephone Minimum Input Sensitivity	35 dB
Good Phone Line Voltage	3 V
Maximum Low Battery Detect	20.4
Minimum Low AC Detect	98
Notification Power	3A max. per output (6A total)

3.2 Environmental Specifications

It is important to protect the SK-5208 control panel from water. To prevent water damage, the following conditions should be AVOIDED when mounting the units:

- Do not mount directly on exterior walls, especially masonry walls (condensation).
- Do not mount directly on exterior walls below grade (condensation).
- Protect from plumbing leaks.
- Protect from splash caused by sprinkler system inspection ports.
- Do not mount in areas with humidity-generating equipment (such as dryers, production machinery).

When selecting a location to mount the SK-5208 control panel, the unit should be mounted where it will NOT be exposed to temperatures outside the range of 0°C-49°C (32°F-120°F) or humidity equal to or greater than 93% at 30°C (89°F) noncondensing.

See also the mounting recommendations in Section 3.5 for additional environmental specifications.

3.3 Wiring Specifications

To avoid induced noise (transfer of electrical energy from one wire to another), keep input wiring isolated from high current output and power wiring. Induced noise can interfere with telephone communication or even cause

false alarms. Avoid pulling one multiconductor cable for the entire panel. Instead, separate the wiring as follows:

	Input/Output Type	Wiring
1/4" spacing must be maintained between each of these circuit types; as well as between power limited and non-power limited circuits.	High Voltage:	AC power
	Low Voltage:	Annunciator, zone circuit wiring, and notification devices
	Audio:	Speaker
	Telco	Separated

DO NOT pull wires from different groups through the same conduit. If you must run them together, do so for as short a distance as possible or use shielded cable. Connect the shield to earth ground at the panel only.

For the same reasons, wiring within the cabinet should be routed around the perimeter of the cabinet. It should not cross the printed circuit board where it could induce noise into the sensitive microelectronics or pick up unwanted RF noise from the high speed circuits.

High frequency noise, such as that produced by the inductive reactance of a speaker or bell, can also be reduced by running the wire through ferrite shield beads or by wrapping it around a ferrite toroid. Figure 3-1 provides an example.

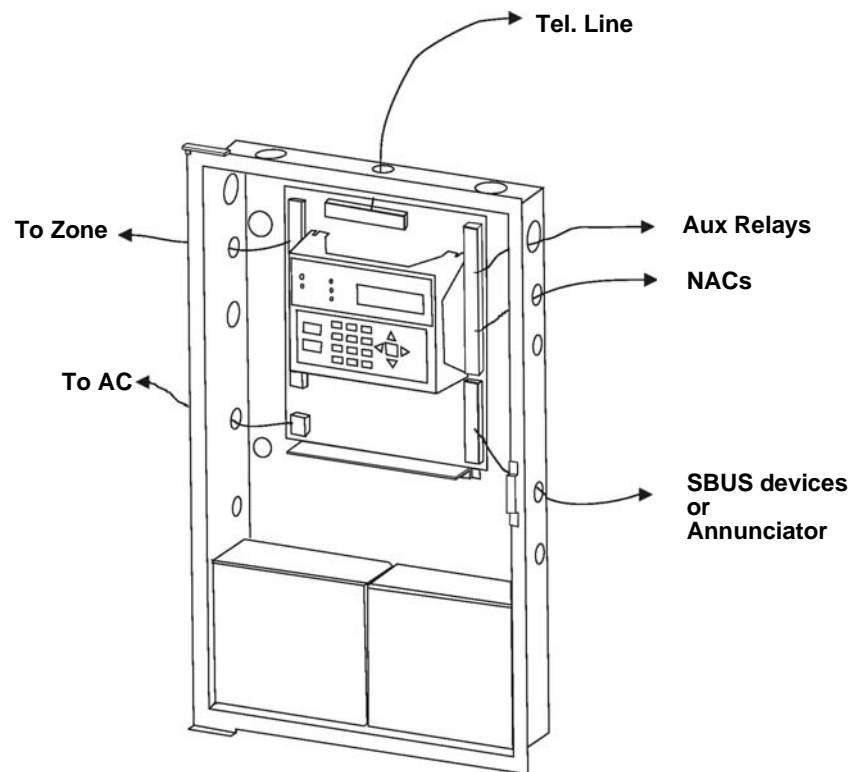

Figure 3-1 Wire Routing Example

3.4 Control Board Components

Figure 3-2 is a wiring diagram for wiring the Model SK-5208 panel.

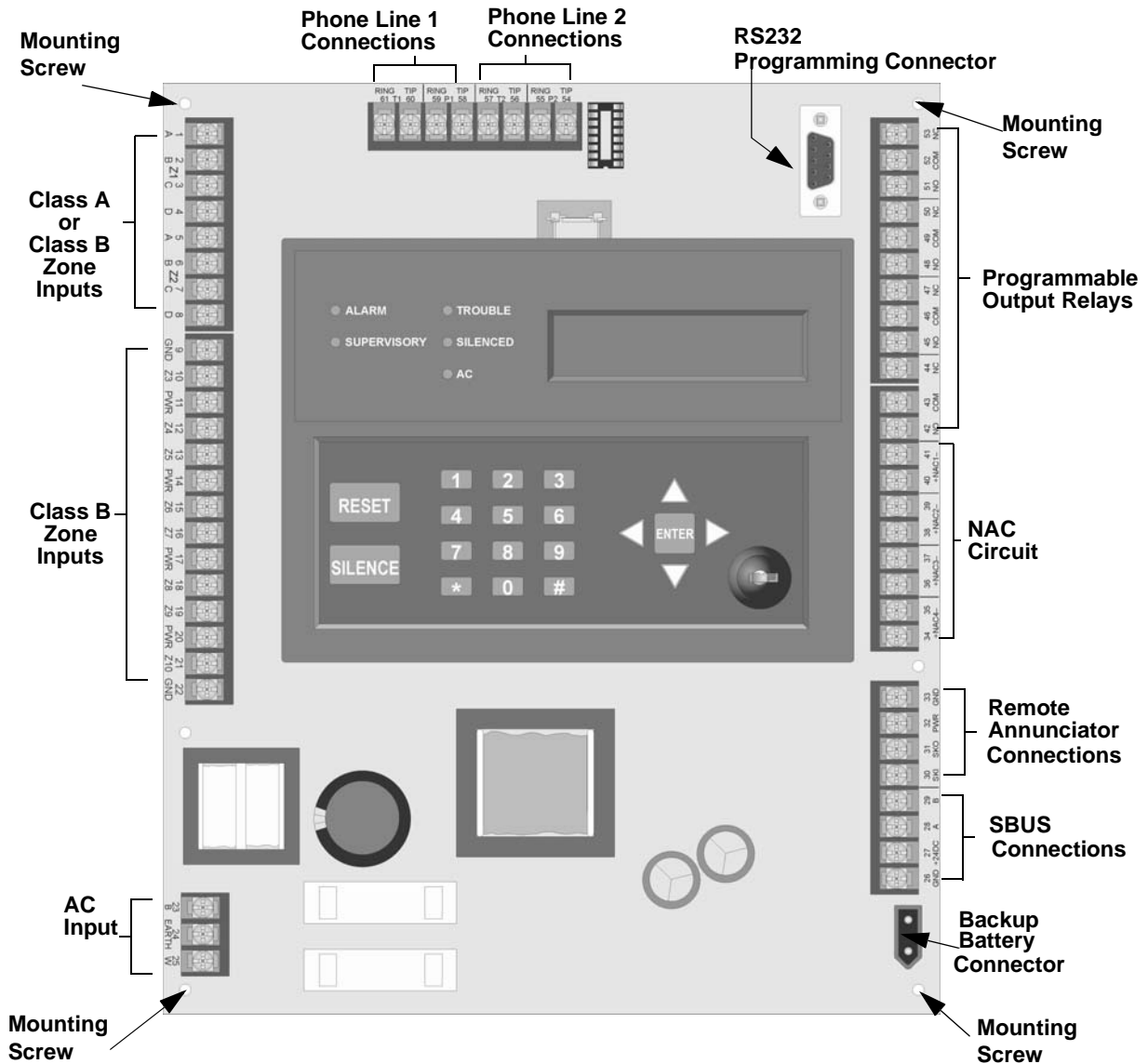

Figure 3-2 Model SK-5208 Board Layout

Refer to Section 3.9 for complete description of control panel terminal connections.

Figure 3-2 shows the 5208 circuit board stack. If you should need to remove the control board for repair, remove the four mounting screws which hold the control board in the cabinet. Then lift the control board out of the cabinet.

3.5 Mounting the SK-5208

Read the environmental specifications in section 3.2 on page 1 before mounting the SK-5208 panel.

The SK-5208 cabinet dimensions are:

16" W x 26.4" H x 4" D (40.64 cm W x 67.06 cm H x 10.16 cm D).

The SK-5208 panel should be located within a secured area, where it is accessible to main drop wiring runs and where it can be easily tested and serviced. End-users responsible for maintaining the panel should be able to hear alarms and troubles. When selecting a location, keep in mind that the panel itself is the main source of alarm and trouble annunciation.

When mounting on interior walls, use appropriate screw anchors in plaster. When mounting on concrete, especially when moisture can accumulate, the enclosure shall be placed or equipped so as to prevent moisture or water from entering and accumulating within the cabinet, and shall be mounted so there is a least 1/4" space between the enclosure and the concrete wall surface. A piece of plywood, standoffs, or other equivalent material can be used to space the cabinet from the concrete surface and then attach the SK-5208 to that spacing surface. Also mount any other desired components to the 1/4" spacing surface.

DO NOT flush-mount the SK-5208 cabinet in a wall designated as a fire break.

3.5.1 Preventing Water Damage

Water damage to the fire system can be caused by moisture entering the cabinet through the conduits. Conduits that are installed to enter the top of the cabinet are most likely to cause water problems. Installers should take reasonable precautions to prevent water from entering the cabinet. Water damage is not covered under warranty.

3.6 Current Draw Calculations

3.6.1 Worksheet Requirements

The following steps must be taken when determining SK-5208 current draw and standby battery requirements.

Filling in the Current Draw Worksheet, Table 3-2 (Section 3.6.2)

1. For the SK-5208, the worst case current draw is listed for the panel and panel accessories. Fill in the number of devices that will be used in the system and compute the current draw requirements for alarm and standby. Record this information in Table 3-2 at Line A.
2. Add up the current draw for all smoke detectors and record in the table at Line B.
3. Add up all notification appliance loads and record in the table at Line C.
4. For notification appliances and auxiliary devices not mentioned in the manual, refer to the device manual for the current ratings.
5. Make sure that the total alarm current you calculated, including current for the panel itself, does not exceed 6.0 A. This is the maximum alarm current for the SK-5208 control panel.

If the current is above 6.0 A you will need to use a notification power expander(s) such as the 5495 to distribute the power loads so that the SK-5208 or the power expanders do not exceed their power rating. Refer to the current draw worksheets provided with the 5495 manuals so you do not exceed their power requirements.

6. Complete the remaining instructions in Table 3-2 for determining battery size requirements.

3.6.2 Current Draw Worksheet

Use Table 3-2 to determine current requirements during alarm/battery standby operation. (Copy the page if additional space is required.)

Table 3-2: Current Draw Calculations

Device	# of Devices	Current per Device		Standby Current	Alarm Current	
For each device use this formula: This column X This column = Current per number of devices.						
SK-5208 Fire Panel (Current draw from battery)	1	Standby:	140 mA	140 mA		
		Alarm:	**550 mA		550 mA	
Panel Accessories						
SK-5217 Zone Expander	(2 max.)	Standby:	60 mA	mA		
		Alarm:	150 mA		mA	
5824 Serial/Parallel Interface Gateway Module	(1 max.)	Standby:	45 mA	mA		
		Alarm:	45 mA		mA	
5220 Direct Connect		Standby:	15 mA	mA		
		Alarm:	15 mA		mA	
SK-5235 Annunciator	(6 max.)	Standby:	30 mA	mA		
		Alarm:	50 mA		mA	
SK-5280 Status Display Module	(8 max.)	Relay (max.)	Standby:	10 mA	mA	
			Alarm:	80 mA		mA
		Outputs	Per output	100 mA		mA
			Max.	700 mA		mA
Total System Current						
Smoke Detectors						
		Standby:	mA	mA		
		Alarm:	mA		mA	
		Standby:	mA	mA		
		Alarm:	mA		mA	
		Standby:	mA	mA		
		Alarm:	mA		mA	
Smoke Detector Current				mA	mA	
Notification Appliances						
		Alarm:	mA		mA	
		Alarm:	mA		mA	
		Alarm:	mA		mA	
Notification Appliances Current					mA	
Additional Devices						
		Standby:	mA			
		Alarm:	mA			
		Standby:	mA			
		Alarm:	mA			
Additional Devices Current					mA	
Total current ratings of all devices in system (line A + line B + C +D)				mA	mA	
Total current ratings converted to amperes (line E x .001):				A	A	
Number of standby hours (24 or 60 for NFPA 72, chapter 1, 1-5.2.5):				H		
Multiply lines F and G. Total standby AH				AH		
Alarm sounding period in hours. (For example, 5 minutes = .0833 hours)					H	
Multiply lines F and I. Total alarm AH					AH	
*Add lines H and J. Total ampere hours required				AH		

* Use next size battery with capacity greater than required.

** The SK-5208 and SK-5217 limits alarm current to 95mA per zone. The SK-5208 alarm current includes

10% of zones in alarm, but in no case less than three zones per UL864

3.6.3 Maximum Battery Standby Load

Table 3-3 shows the maximum battery standby load for the SK-5208 based on 24 and 60 hours of standby. The standby load calculations of line D in the Current Draw Calculation Worksheet (Table 3-2) must be less than the number shown in Table 3-3 for the battery size used and standby hours required.

Batteries larger than 18 AH will not fit into the SK-5208 cabinet and must be housed in the RBB remote battery box cabinet. See Section 3.8 for battery installation.

Table 3-3: Maximum Battery Standby Load

Rechargeable Battery Size	Max. Load for 24 hrs. Standby, 5 mins. Alarm	*Max. Load for 60 hrs. Standby, 5 mins. Alarm
7 AH	270 mA	105 mA
12 AH	475 mA	190 mA
18 AH	685 mA	270 mA
35 AH	1.1 A	450 mA

* Required for NFPA 72 Auxiliary Protected Fire Alarm systems for Fire Alarm Service (City Box) and Remote Station Protected Fire Alarm systems (Polarity Reversal) and Digital Alarm Communicator/Transmitter (DACT).

Warning!

Silent Knight does not support the use of batteries smaller than those listed in Table 3-3. If you use a battery too small for the installation, the system could overload the battery resulting in the installation having less than the required 24 hours standby power. Use Table 3-2 to calculate the correct battery amperes/hour rating needed for your installation.

3.7 AC Wiring

The Model SK-5208 power supply delivers 24 VDC at 6A for smoke detector power, notification device power, and accessory power. Figure 3-3 shows the AC connections to the SK-5208 control panel.

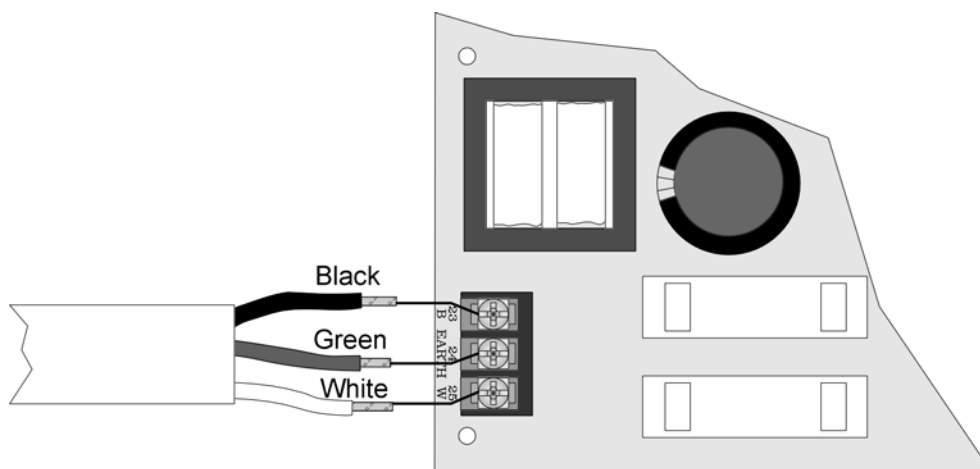

Figure 3-3 AC Wiring

Warning

To reduce the risk of electrical shock, make sure that all power has been turned off or disconnected before attempting to connect the Model SK-5208 control panel. Do NOT apply power to this panel until all accessories are properly connected.

Note: Note: All conduit and wiring connected to the SK-5208 must meet the applicable National Electric Code, NFPA Standards, state, and local building code requirements. In all cases, the authority having jurisdiction takes precedence.

3.8 Backup Batteries

The control panel battery charge capacity is 7.0 to 35.0 AH. Use 12V batteries of the same AH rating. Determine the correct AH rating as per your current load calculation (see 3.6.2).

Wire batteries in series to produce a 24-volt equivalent. Do not parallel batteries to increase the AH rating.

Batteries larger than 18 AH (not to exceed 35 AH) use the RBB Remote Battery Box. It is recommended that you replace the batteries every five years. The following steps and diagram explain how to connect the batteries.

1. Connect the black wire to the negative (-) side of battery #1.
2. Connect the jumper wire provided (P/N 140694) from the positive (+) side of battery #1 to the negative side of battery #2.
3. Connect the red wire to the positive (+) side of battery #2

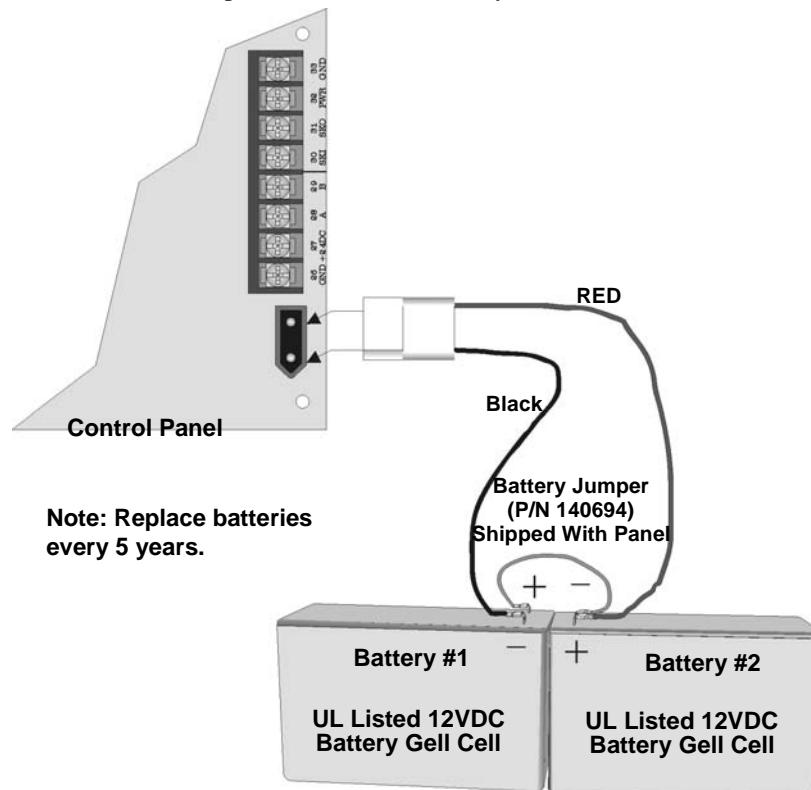

Caution

Apply AC power before connecting the batteries to the power supply to prevent arcing on battery terminals.

Note: The total current draw on smoke power, accessory power, and notification device outputs must not exceed 6A.

3.9 Terminal Strip Description

The terminal strips on the PC board are non-removable. Table 3-4 lists the functions of each terminal. See Section 3.4 for the board layout.

Table 3-4: Terminal Descriptions

Function	Terminal Number	Terminal Label	Comments
Zone 1 input.	1	A	Zone 1 input Class A (Style D) or Class B (Style B). See Section 3.11 for wiring configurations.
	2	B	
	3	C	
	4	D	
Zone 2 input	5	A	Zone 2 input Class A (Style D) or Class B (Style B). See Section 3.11 for wiring configurations.
	6	B	
	7	C	
	8	D	
Ground	9	GND	
Zone 3 input	10	Z3	Zone input Class B (Style B). Refer to Section 3.11.2. Power Limited at 100mA. Voltage 27.4 VDC.
Power (Zone 3 & 4)	11	PWR	
Zone 4 input	12	Z4	
Zone 5 input	13	Z5	
Smoke Power	14	PWR	
Zone 6 input	15	Z6	
Zone 7 input	16	Z7	
Smoke Power	17	PWR	
Zone 8 input	18	Z8	
Zone9 input	19	Z9	
Smoke Power	20	PWR	
Zone 10 input	21	Z10	
Ground	22	GND	
AC Power Connections	23	B	
	24	Earth	
	25	W	
SBUS Connections	26	GND	Used to connect SK-5217 Zone Expanders and 5280 Status Display Modules to the control panel. Accessory Power (terminals 26 and 27) provides 1 Amp total current.
	27	+24DC	
	28	A	
	29	B	

Table 3-4: Terminal Descriptions

Function	Terminal Number	Terminal Label		Comments	
Remote Annunciator Connections	30	SKI		Used to connect 5235 remote annunciators to the control panel.	
	31	SKO			
	32	PWR			
	33	GND			
Notification Appliance Circuit 4	34	+	NAC4	3 Amp maximum per circuit. Voltage 27.4 VDC, 1.5 Ohms Maximum. Note: Total control panel current is 6 Amps.	
	35	-			
Notification Appliance Circuit 3	36	+	NAC3		
	37	-			
Notification Appliance Circuit 2	38	+	NAC2		
	39	-			
Notification Appliance Circuit 1	40	+	NAC1		
	41	-			
Auxiliary Relay 4	42	NO			Relay contacts are rated at 2.5 A, 24 VDC/24VAC (inductive rating). 5A, 24 VDC/24 VAC (resistive). Connect to power limited source only.
	43	COM			
	44	NC			
Auxiliary Relay 3	45	NO			
	46	COM			
	47	NC			
Auxiliary Relay 2	48	NO			
	49	COM			
	50	NC			
Auxiliary Relay 1	51	NO			
	52	COM			
	53	NC			
Telco Line 2	54	TIP	P2	Telephone line 2 connection terminals (see Section 3.10 for wiring diagram).	
	55	RING			
	56	TIP	T2		
	57	RING			
Telco Line 1	58	TIP	P1		
	59	RING			
	60	TIP	T1		
	61	RING			

3.10 Telephone Line Connection

The SK-5208 connects to two separate telephone lines to report data to the central station. An RJ31X jack should be installed by the telephone company for each line. Figure 3-4 shows how to wire the telephone line interconnect cords (not provided) to the SK-5208.

Note: To reduce the possibility of false alarms and transient damage, DO NOT bundle telephone wires together with initiation or notification device wires.

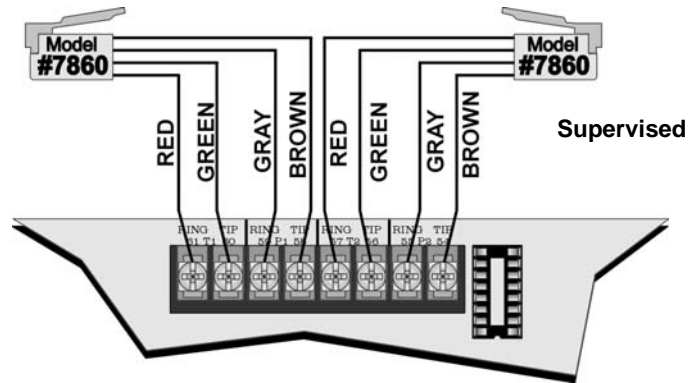

Figure 3-4 Telephone Line Connection

The letter designator on the phone input indicates whether it is the Telco or House side of the phone circuit. For example terminals 60 and 61 are labeled T1, T = Telco side of the phone circuit and terminals 58 and 59 are labeled P1, P = Premise (House) side of the phone circuit.

The SK-5208 has built-in dual phone line monitors. These circuits will detect any fault in the phone lines by monitoring the DC voltage present on the lines. If phone line voltage drops below 3 VDC and is not corrected within approximately 60 seconds, an audible trouble signal will sound and the panel will report a line fault trouble over the remaining phone line.

A situation could occur where both phone lines appear to be good, but the dialer cannot get through to the central station on the first line. In this case, the SK-5208 will switch phone lines and attempt the call again using the second line. Make sure the phone lines are programmed properly (see Section 4).

Note: To comply with industry standards, this product is equipped with line seizure. Any time the system's dialer needs to communicate with the central station, it will not be possible to use any telephones that are on the same line(s) as the system. Normally, this condition will last approximately one minute, but under adverse telephone circuit conditions, could last for as long as 15 minutes.

3.11 Detector Installation

3.11.1 Class A (Style D) Zones

Zones 1 and 2 may be selected through programming as Class A (Style D) zones (see Section 4.2.2 for zone style programming). See Section 3.11.2 for Class B (Style B) configuration.

Each class A zone is a four-wire circuit that allows an alarm to be detected even after a single open or ground fault occurs. When a single open or ground fault occurs, the audible trouble signal will sound and the SK-5208 will report the trouble to the central station or remote station (if programmed to report troubles). If reporting to a remote station troubles may be transmitted to a secondary location.

Figure 3-5 shows how to wire a Class A (Style D) circuit. No end-of-line (EOL) resistors are needed for these

zones. These zones must be wired using normally open contacts.

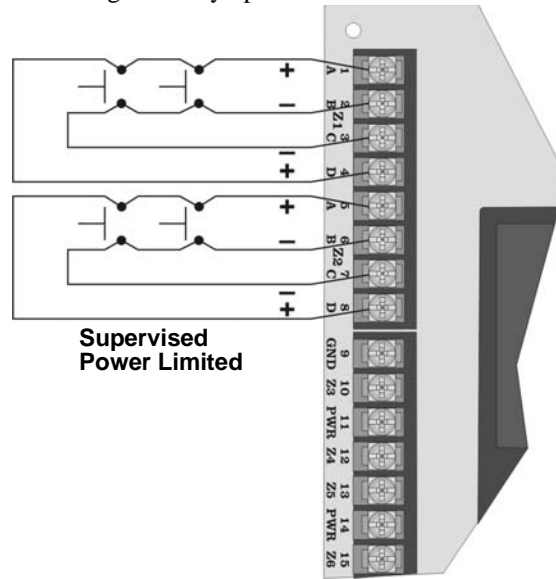

Figure 3-5 Class A (Style D) Supervised Fire Circuit

Maximum voltage: 17.5 to 28 VDC Full Wave Rectified
 Circuit Current: 95 mA
 Maximum circuit Resistance: 50 ohms

3.11.2 Class B (Style B) Zones

Zones 3 through 10 are Class B (Style B) only fire zones. Zones 1 & 2 may also be programmed as Class A (Style D) or Class B (Style B), see Section 4.2.2 for zone 1 & 2 zone programming.

Each Class B zone consists of a two-wire circuit that will detect the occurrence of an open in the circuit, but may not be able to detect an alarm after such an occurrence. The detection of an open will cause the audible trouble signal to sound and the SK-5208 will report the trouble to the central or remote station (if programmed to do so).

Figure 3-6 shows how to wire a Class B (Style B) circuit. One side of each Class B circuit connects to a zone input terminal and the other side of each circuit connects to Smoke power. For each circuit, use a 4.7K-ohm EOL resistor wired in parallel with the normally open contact farthest from the panel.

Note: Zones 1 and 2 can be configured as either Class A or Class B. See also Section 3.11.1.

**4.7 kΩ EOL
 UL Listed
 Model 7628**

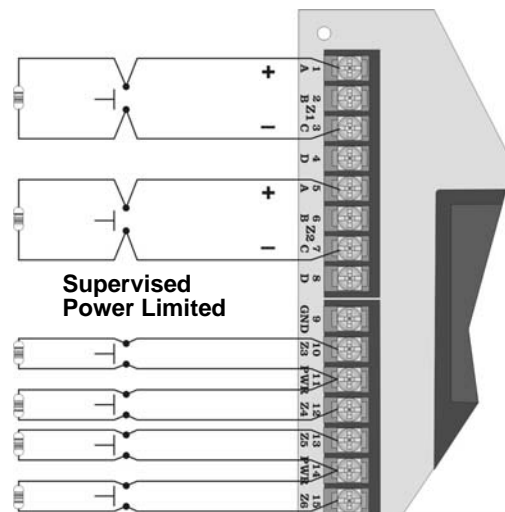

Figure 3-6 Model SK-5208 Class B (Style B) Circuits

Maximum circuit Resistance - 50 ohms
 Maximum Total alarm current for all Class B (Style B) zones - 1 A
 Maximum Standby Current per Zone:3.0 mA
 Maximum Alarm Current per Zone:95 mA

3.11.3 Four-Wire Smoke Detector Connection

Figure 3-7 illustrates how UL listed four-wire smoke detectors must be connected to Class B (Style B) zones.

When wiring a four-wire smoke detector to the Class B (Style B) zones, you must use a Power Supervision Unit, such as Silent Knight's 160150.

Note: Mount the PAM-2 and the end-of-line resistor at the last device on the circuit.

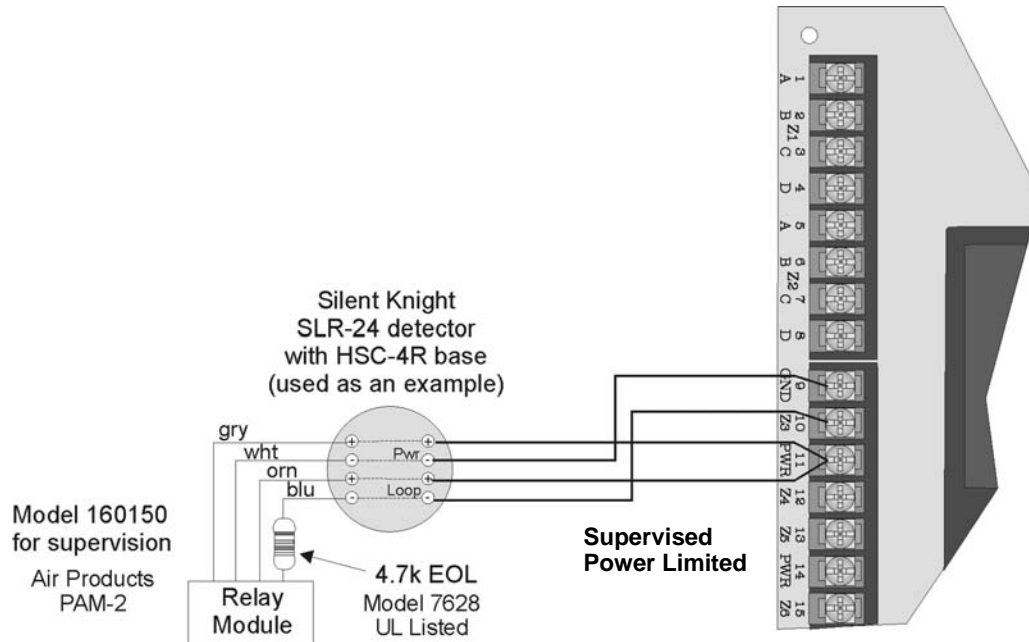

Figure 3-7 Four-Wire Smoke Detector Wiring

See Appendix A for a list of four-wire smoke detectors that may be used with the SK-5208.

3.11.4 Two-Wire Smoke Detector Connection

Figure 3-8 shows how to connect two-wire smoke detectors to Class B (Style B) zones.

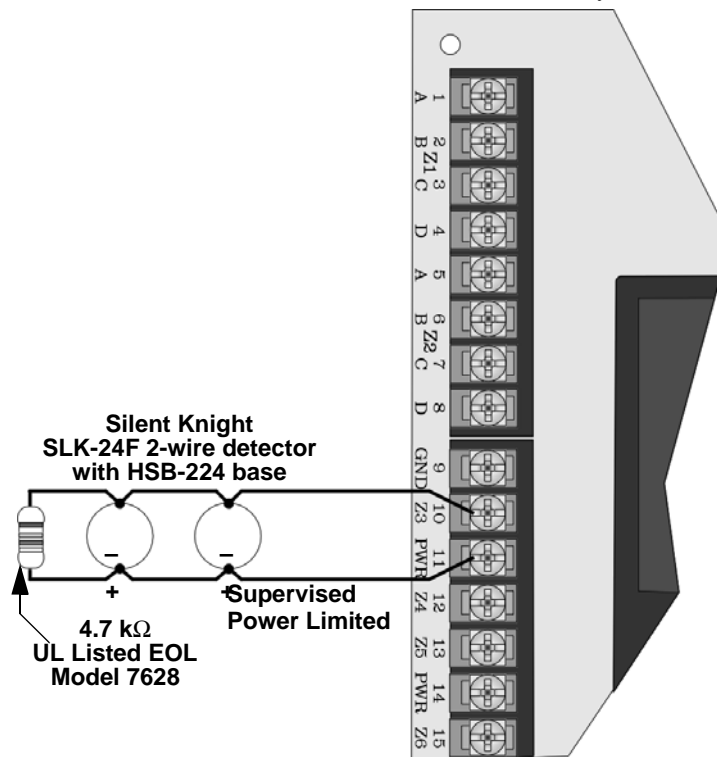

Figure 3-8 Two-Wire Smoke Detector Wiring

See Appendix A for a list of two-wire smoke detectors that may be used with the SK-5208.

Note: Two-wire detectors can be configured for Enhanced Mode. Enhanced mode is smoke verification for zones with 2-wire detectors and contact type devices, such as pull stations, used on the same circuit. If the alarm current is greater than 78 mA, the smoke verification cycle will not occur. See Section 4.2.1 Verify Options under the Zone Options Menu to program initiation circuits for enhanced mode.

3.12 Supervised Notification Appliance Outputs

Note: To reduce the possibility of false alarms and transient damage, DO NOT bundle telephone wires together with notification circuit wires.

The SK-5208 provides four Class B (Style Y) supervised notification circuit outputs to annunciate alarm conditions. For proper operation, you must use polarized sounding devices with a 4.7k ohm end-of-line resistor

on each circuit. Figure 3-9 shows how to connect the notification circuits to the SK-5208.

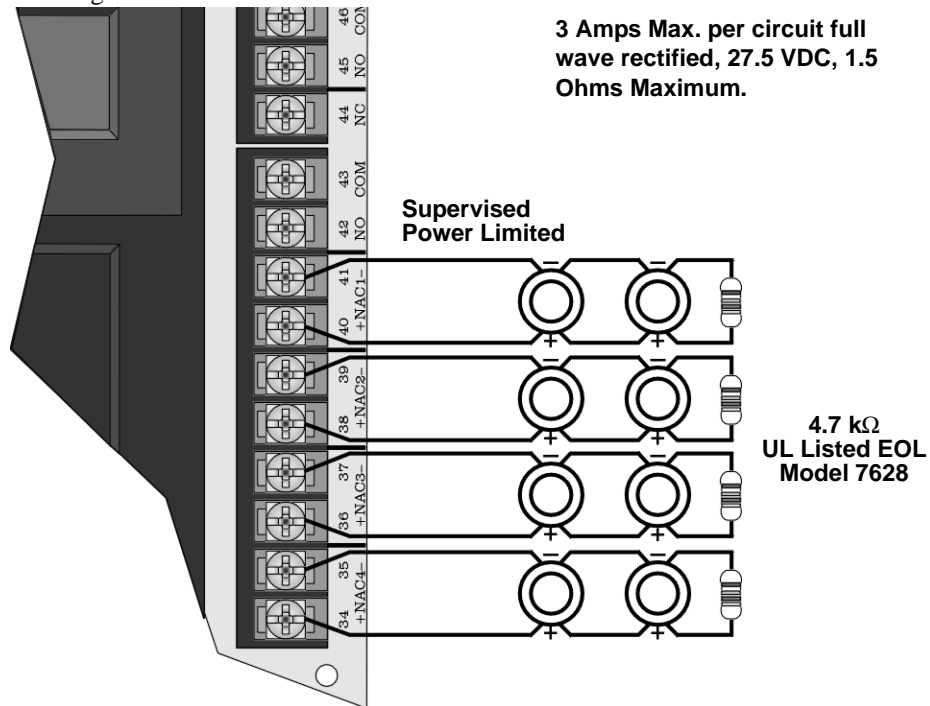

Figure 3-9 Supervised Notification Appliance Wiring

3 Amp maximum current draw from any single NAC output (not to exceed a total current draw of 6 amps for the control panel). See Appendix A for a list of the UL notification appliances that can be used with the SK-5208. Contact Silent Knight if you have any questions about compatible notification circuits.

All circuit are regulated unless used for releasing service in which case they are considered special applications. See Section 5.5 for details on releasing.

3.13 Auxiliary Relays

The SK-5208 provides four programmable auxiliary relay outputs. Relays can be programmed to activate for the following conditions, either for all zones or by individual zone: pre-alarm (not acceptable for NFPA 72 Central Station), fire alarm, auxiliary alarm, alarm by zone, and system or circuit troubles (loss of AC, low battery, failed to communicate, phone line troubles, fire drills, and notification circuit troubles).

Refer to the SK-5208 programming manual for more information. Figure 3-10 shows the relay contact connections using a door holder application as an example.

Note: Relays programmed as “Trouble” will be active during normal state and deactivated during a trouble condition.

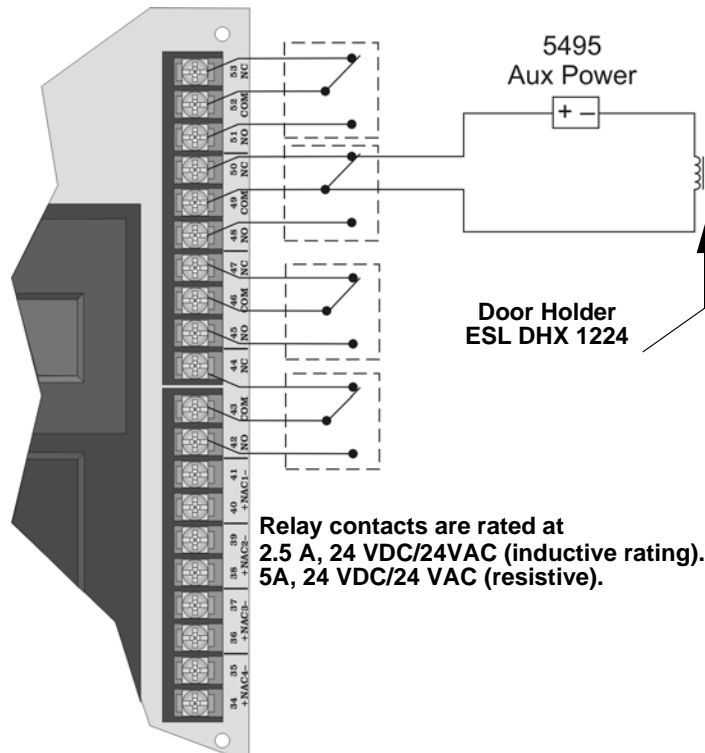

Figure 3-10 Auxiliary Relays

3.14 Accessory Devices

The section describes how to install the SK-5235 Remote Annunciator, SK-5217 Zone Expander, the 5824 Serial/Parallel Printer Module, and the SK-5280 Status Display Module. All circuits are 24 VDC regulated. All S-Bus devices are Style 1 Class B as per NFPA 72.

3.14.1 Setting ID Codes

Before installing the SK-5235, SK-5217, 5824 or SK-5280, you must first set their identification codes. Each device must be given its own identification code. For example: each SK-5235 needs a unique ID code, but a SK-5235 can have the same ID code as a SK-5217. Each type of device has its own device type programmed into it enabling the control panel to distinguish between the different devices.

On the back of each device is a small 4-position dip switch used to set the ID code. Use the chart below to

determine the dip switch positions for each possible ID code.

Table 3-5: ID Dip Switch Settings

ID Number	Switches ¹			
	1	2	3	4
0 ²	Down	Down	Down	Down
1	Up	Down	Down	Down
2	Down	Up	Down	Down
3	Up	Up	Down	Down
4	Down	Down	Up	Down
5	Up	Down	Up	Down
6	Down	Up	Up	Down
7	Not used ³			
8				

1. Switch Settings: Up = On Down = Off

2. Not supervised.

3. ID number 7 and 8 are not valid ID settings.

3.14.2 Model SK-5235 Remote Annunciator

The SK-5235 performs all system operation. It also provides trouble and alarm information and can be used for programming. The control panel can support up to six SK-5235 Remote Annunciators.

Upon initial power up, the address of each SK-5235 is displayed on the LCD. (Annunciators with address 0 will not be supervised.)

3.14.2.1 Mounting the SK-5235 Remote Annunciator

The SK-5235 Remote Annunciators must be mounted on a dual gang electrical box.

To mount the annunciator:

1. Remove the rear mounting plate by inserting a #4 flat blade screwdriver into the slots on the bottom edge of the annunciator. See Figure 3-11. Gently turn the screwdriver until the mounting plate pulls away from the frame.

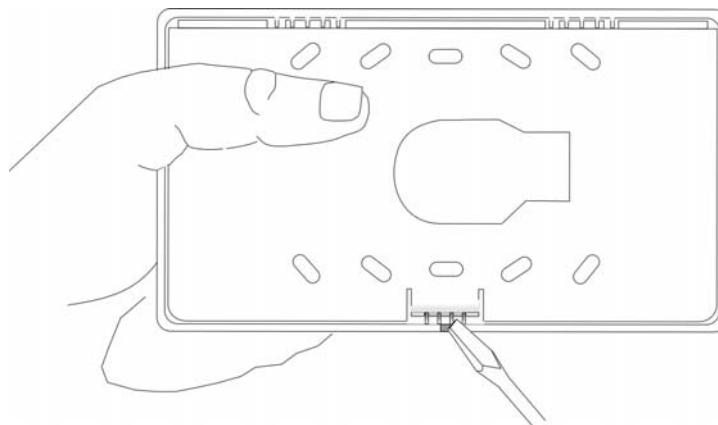

Figure 3-11 Rear Mounting Plate Removal

2. Secure it to the wall using #6 or #8 screws. The mounting plate should be oriented so that the word TOP is toward the top of the plate and facing you. A square hole is provided in the mounting plate to run the wiring to the annunciator.
3. When all of the wires have been connected to the annunciator, set the top of the annunciator over the tabs on the top of the mounting plate. Make sure the wires do not get pinched between the frame and the mounting plate. Press each corner of the bottom side onto the annunciator mounting plate until you hear it click. You may have to gently squeeze the annunciator (top to bottom) to align it while snapping the bottom edge into place.

3.14.2.2 Wiring the SK-5235

Follow these steps to properly wire the SK-5235 to the control panel.

1. Remove power from the control panel.
2. Wire the SK-5235s as shown in Figure 3-12.
3. Set the ID number. See Table 3-5.

Note: The ID number of 7 is reserved for the built-in touchpad on the SK-5208.

4. Reapply power the control panel.

When the annunciator powers up, it will display its ID code and current status of the panel.

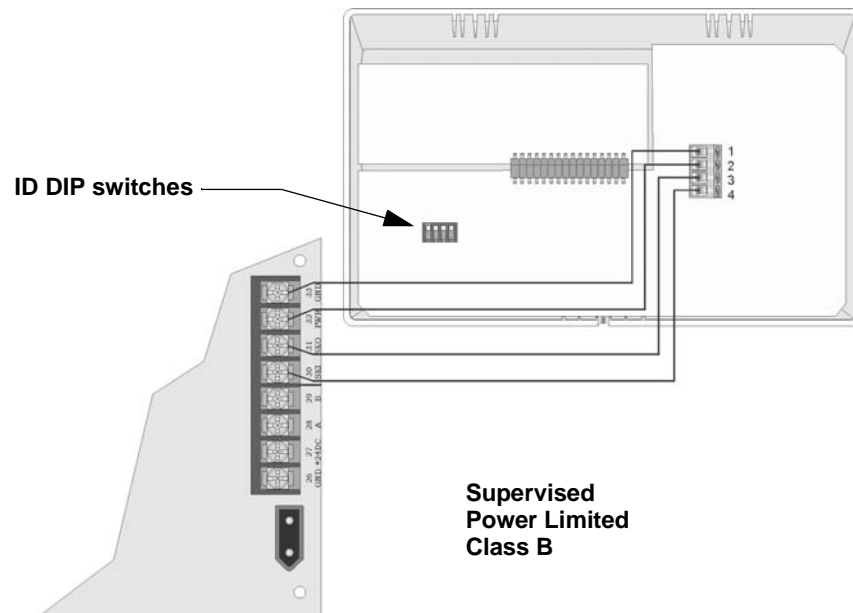

Figure 3-12 Model SK-5235 Connection

Note: Each 5235 touchpad can be individually supervised. See Section 4.2.2 for programming touchpads as supervised.

3.14.3 Model SK-5280 Status Display Module

The Model SK-5280 Status Display module provides outputs and control functions for remote annunciation of alarm, trouble, and supervisories for each zone. The system can supervise up to eight SK-5280 Status Display Modules.

Note: The driver outputs are non-supervised. Relays must be connected to power limited sources only.

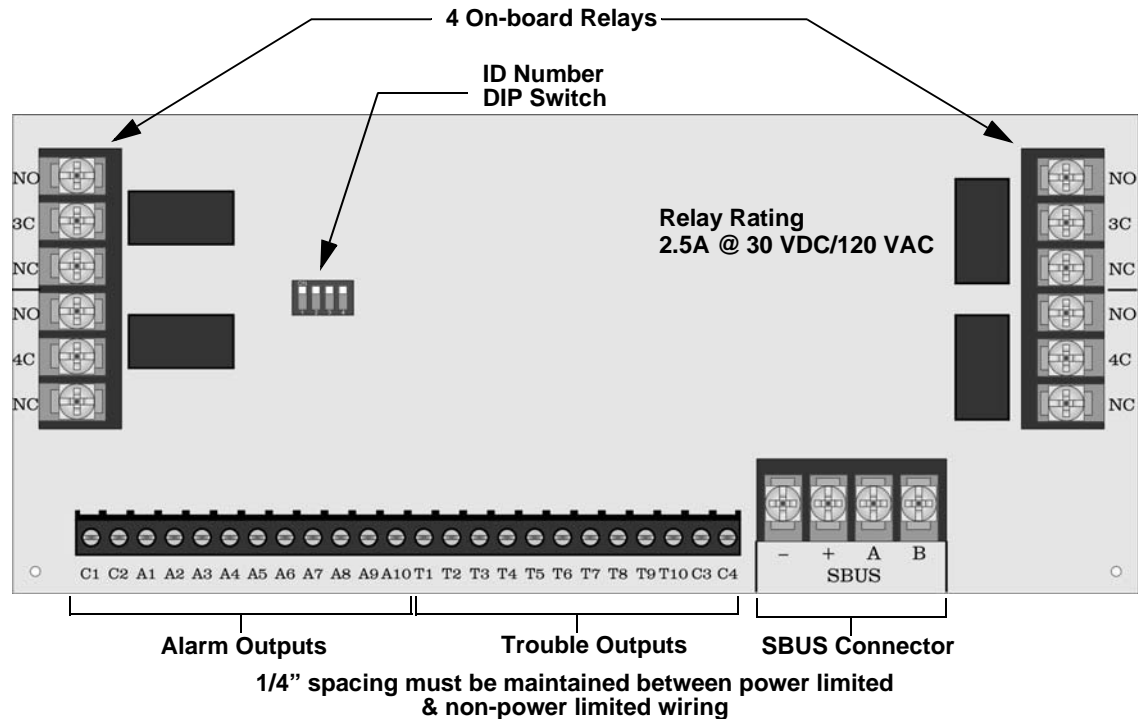

Figure 3-13 Model 5280 Board Layout

The SK-5280 has 1 connector which has 10 outputs for alarms and 10 outputs for trouble annunciation. These outputs are active low. Each output can provide up to 100 mA of current, with a total limitation of 700 mA.

The module has 4 normally open non-dedicated relays that can be wired to be active with any of the outputs.

Wire the SK-5280 as shown in Figure 3-14. Maintain a physical separation of one-half inch or more between field wires and connection points to prevent damage from transients.

Note: SILENCE does not affect SK-5280 outputs. To reset a SK-5280 output, the alarm or trouble condition must be restored.

The SK-5280 can be used to interface to LED annunciator.

The SK-5280 can be programmed to indicate alarms and trouble status for; zones 1 - 10, zones 11 - 20, zones 21

- 30, or system status outputs. See Section 4.2.11.

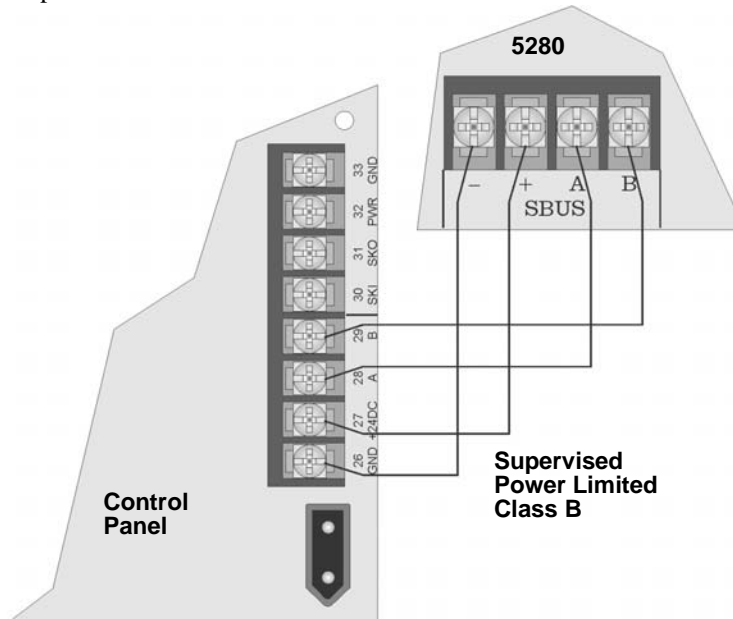

Figure 3-14 Model SK-5280 Connection to the Control Panel

3.14.3.1 Mounting the SK-5280

The SK-5280 into a metal bracket and standoffs in the SK-5208 cabinet or into SK-2190 accessory cabinet.

Mounting the SK-5280 into SK-5208 Cabinet

Follow these steps to properly mount the SK-5280 into the SK-5208 cabinet:

1. Remove power from the control panel.
2. Mount the SK-5280 onto the standoffs and bracket located in the cabinet. See Figure 3-15.

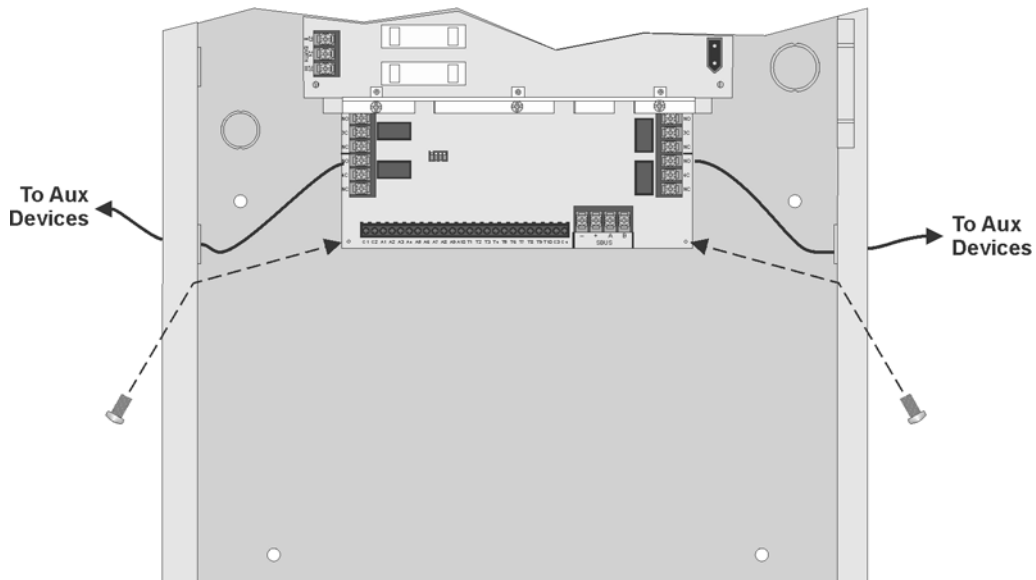

Figure 3-15 Installing the 5280 Into the 5208 Cabinet

3. Connect the SK-5280 to the SK-5208 control panel as shown in Figure 3-14.
4. Set the ID number (see Figure 3-13 for ID DIP switch location). See also Section 3.14.1 for information on setting ID numbers.
5. Reconnect power to the control panel.

Mounting the SK-5280 into the SK-2190 Accessory Cabinet.

Follow these steps to properly mount the SK-5280 into the SK-2190 cabinet:

1. Mount the remote cabinet using the cabinet mounting holes. See Figure 3-16.
Refer to Section 3.5 for proper cabinet mounting procedures.
2. Remove power from the control panel.
3. Mount the SK-5280 onto the standoffs and bracket located in the cabinet. See Figure 3-16.

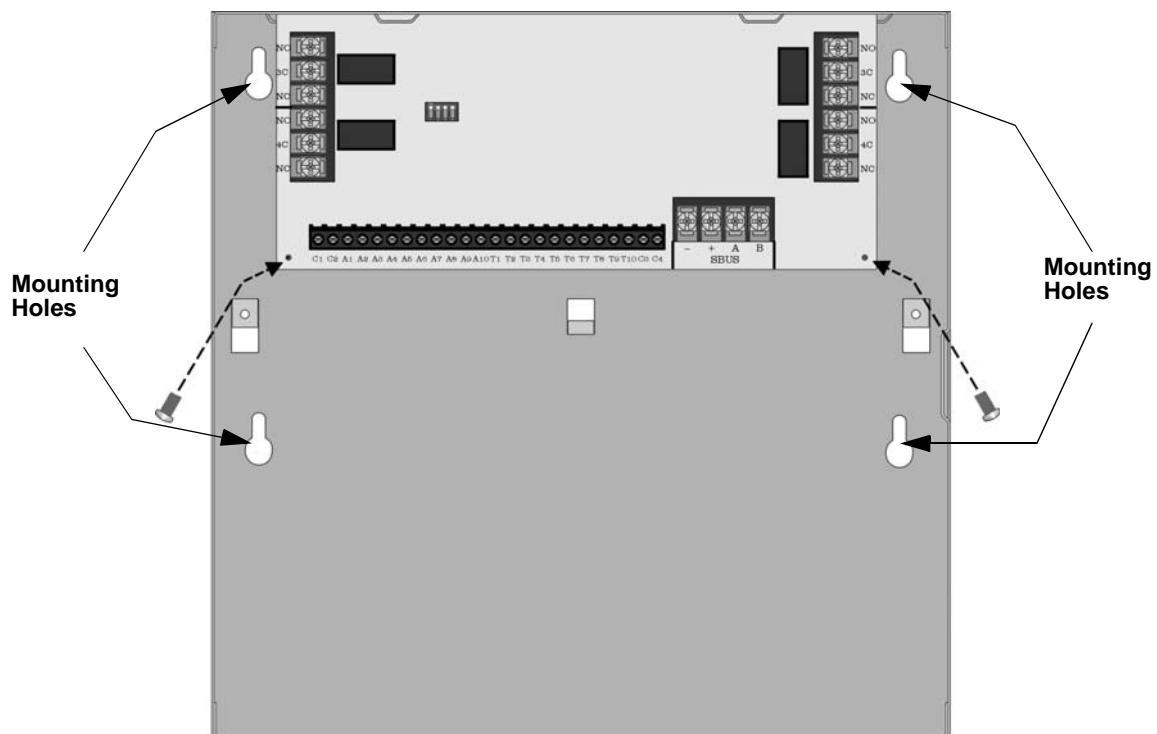

Figure 3-16 Model SK-5280 Remote Installation

4. Connect the SK-5280 to the SK-5208 control panel as shown in Figure 3-14.
5. Set the ID number (see Figure 3-13 for ID DIP switch location). See also Section 3.14.1 for information on setting ID numbers.
6. Reconnect power to the control panel.

3.14.3.2 Wiring Relays

The four on-board relays can be triggered by the active low outputs. For example, the alarm outputs can all be wired to relay 3 and the trouble outputs can be wired to relay 4 (see Figure 3-17).

C1 is the coil for the relay 1, C2 is the coil for relay 2, C3 and C4 are the coils for relays 3 and 4 respectively.

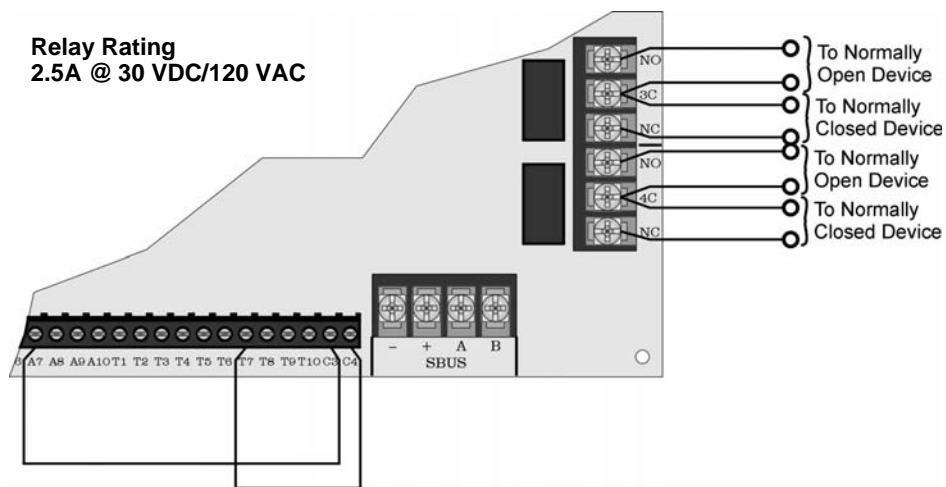

Figure 3-17 Relay Wiring on the SK-5280

Note: Figure 3-17 uses A7 and T7 to activate relays 3 and 4 as an example. However, any of the outputs can be used to trip any of the relays.

3.14.3.3 Wiring LEDs to Outputs

The outputs (A1-A10 and T1-T10) can be used to operate LEDs used in a remote annunciator (see Figure 3-18). Outputs A1-A10 are alarm outputs for the zones corresponding to those outputs. For example, if the SK-5280 is programmed to output for zones 11-20, then outputs A1-A10 will correspond with zones 11 through 20.

Outputs T1-T10 are trouble outputs for the zones corresponding to those outputs. for example, if the SK-5280 is programmed to output for zones 21-30, then outputs T1-T10 will correspond with zones 21-30.

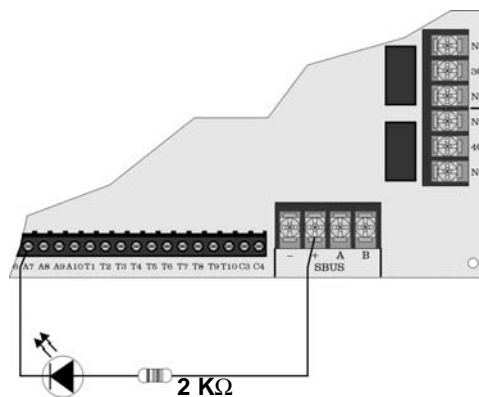

Figure 3-18 LED Wiring on the SK-5280

3.14.4 Model SK-5217 Zone Expander Installation

The Model SK-5217 provides the SK-5208 with ten additional Class B (style B) zones. The SK-5217 connects to the SK-5208 control panel via the SBUS as shown in Figure 3-19.

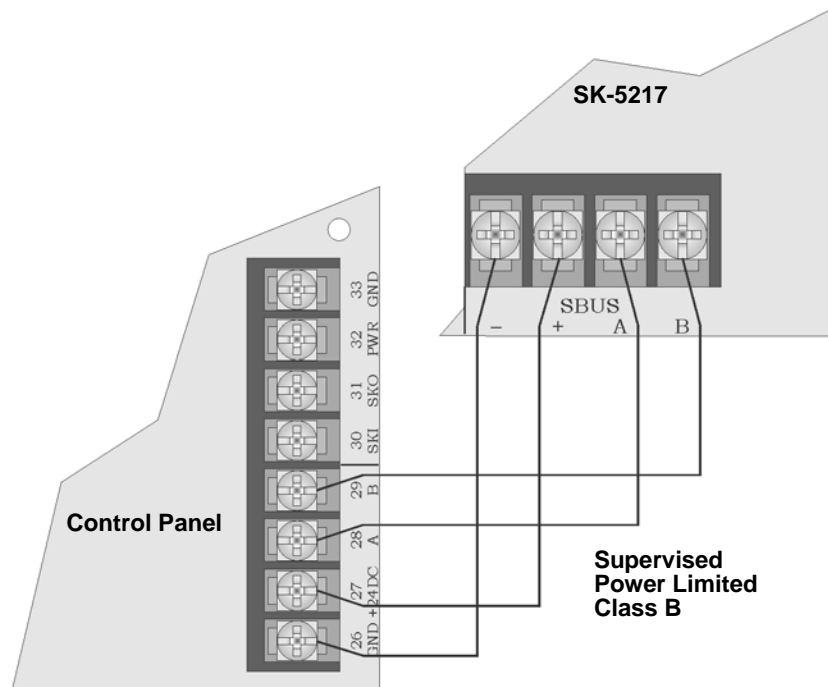

Figure 3-19 SBUS Connections

3.14.4.1 Zone Inputs

Figure 3-20 and Figure 3-21 shows how to wire detectors to the SK-5217. Use a 4.7k end of line resistor for each Class B circuit. The EOL must be wired in parallel with the normally open contact farthest from the panel. See Appendix A for a list of the smoke detectors that can be used with the SK-5217.

Maximum circuit Resistance - 50 ohms

Maximum Total alarm current for all class B (style A) zones - 1 A

Maximum Standby Current per Zone: 3.0 mA

Maximum Alarm Current per Zone: 95 mA

Voltage: 17.5 to 28 VDC

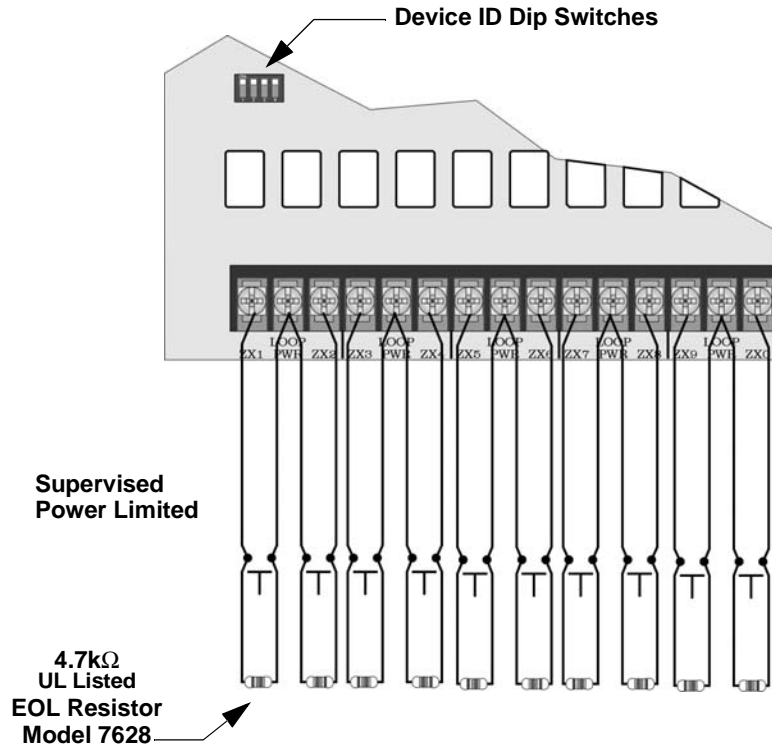

Figure 3-20 Model SK-5217 Two-wire Detectors

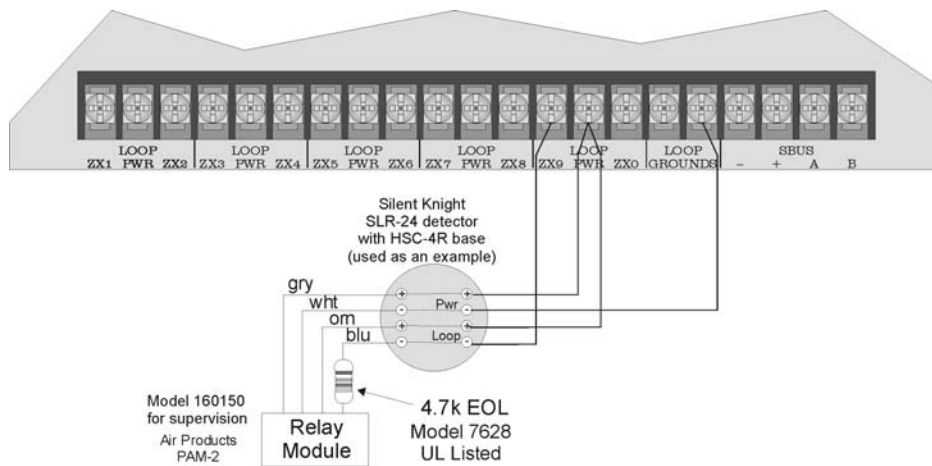

Figure 3-21 4-Wire Detector Connections

3.14.4.2 Mounting Instructions

The SK-5217 into a metal bracket and standoffs in the SK-5208 cabinet or into SK-2190 accessory cabinet.

Mounting the SK-5217 into SK-5208 Cabinet

Follow these steps to properly mount the SK-5217 zone expander into the SK-5208 cabinet:

1. Remove power from the control panel.
2. Mount the SK-5217 onto the standoffs and bracket located in the cabinet. See Figure 3-22.

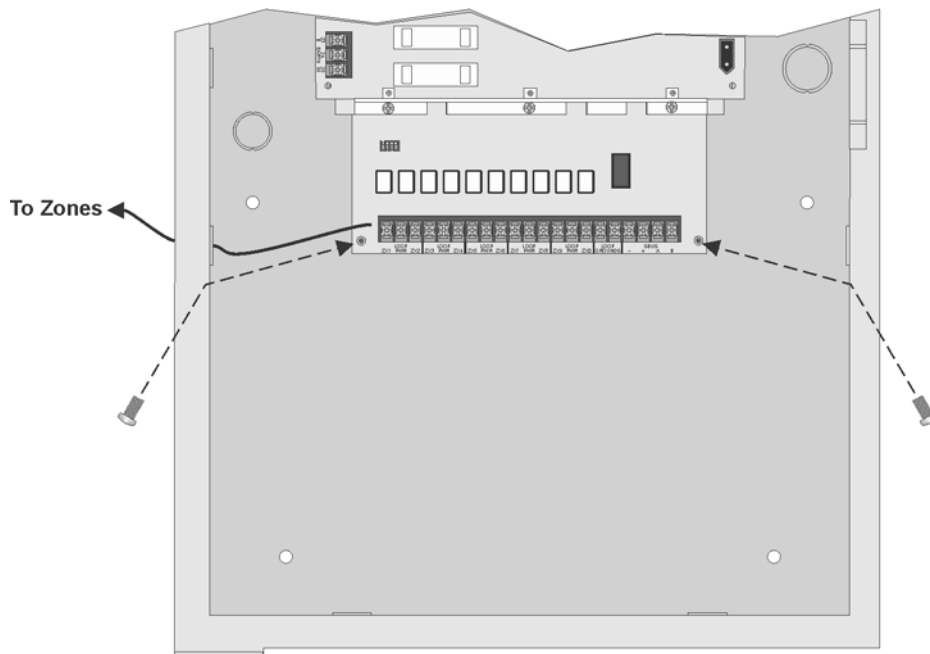

Figure 3-22 Installing the SK-5217 Into the SK-5208 Cabinet

3. Connect the SK-5217 to the SK-5208 control panel as shown in Figure 3-19.
4. Wire the zone inputs to the zone expander as shown in Figure 3-20.
5. Set the ID code (see Section 3.14.1).
 - If ID code 1 is selected the SK-5217 will input zones 11 - 20.
 - If ID code 2 is selected the SK-5217 will input zones 21 - 30.
6. Reconnect power to the control panel.

Mounting the SK-5217 into the SK-2190 Accessory Cabinet.

Follow these steps to properly mount the SK-5217 zone expander into the SK-2190 cabinet:

1. Mount the remote cabinet using the cabinet mounting holes. See Figure 3-23.
 - Refer to Section 3.5 for proper cabinet mounting procedures.
2. Remove power from the control panel.

3. Mount the SK-5217 onto the standoffs and bracket located in the cabinet. See Figure 3-23.

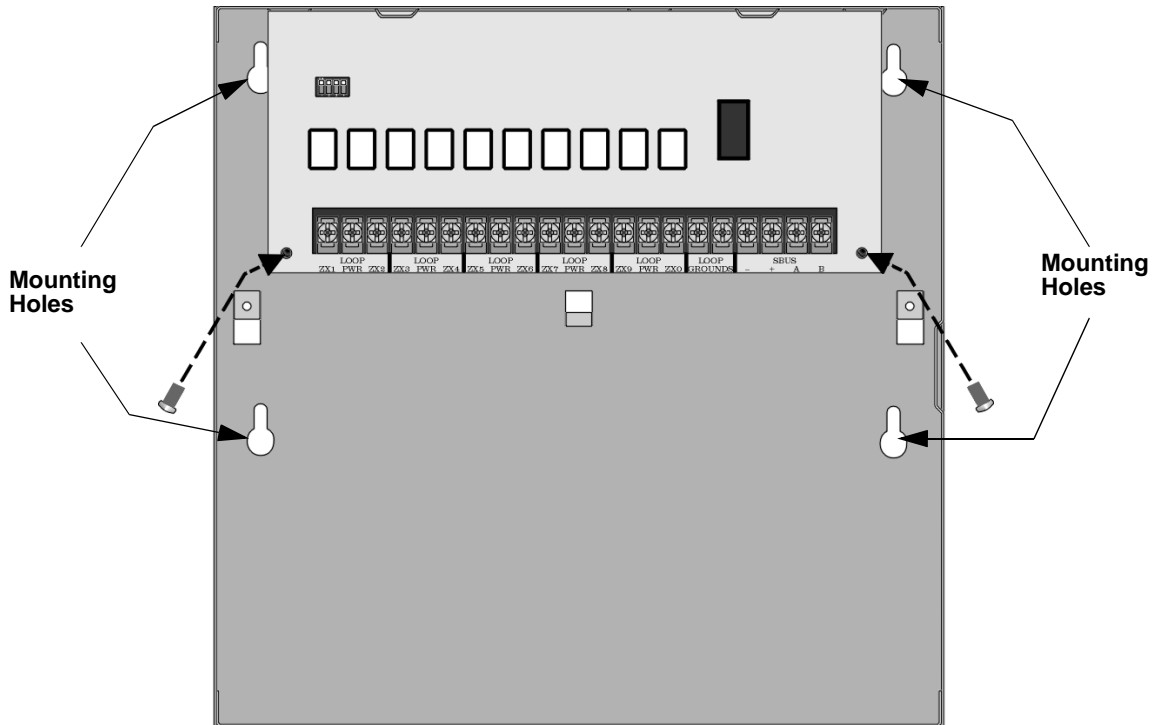

Figure 3-23 Model SK-5217 Remote Installation

4. Connect the SK-5217 to the SK-5208 control panel as shown in Figure 3-19.
5. Set the ID code (see Section 3.14.1).
 If ID code 1 is selected the SK-5217 will input zones 11 - 20.
 If ID code 2 is selected the SK-5217 will input zones 21 - 30.
6. Wire the zone inputs to the zone expander as shown in Figure 3-20.

3.14.5 Model 5824 Installation Instructions

The Model 5824 provides the 5208 with the ability to communicate to a serial or parallel printer to print the event log. You can use one 5824 on the 5208. The 5824 is for ancillary use only.

3.14.5.1 Mounting the 5824 Module

The 5824 comes in a plastic enclosure, follow these steps to mount the 5824's plastic enclosure:

1. Remove the 5824's cover. Use a small screw driver if necessary.

- Remove the 5824 circuit board from the base by pushing outward on the base snap retaining tabs and lifting the circuit board out.

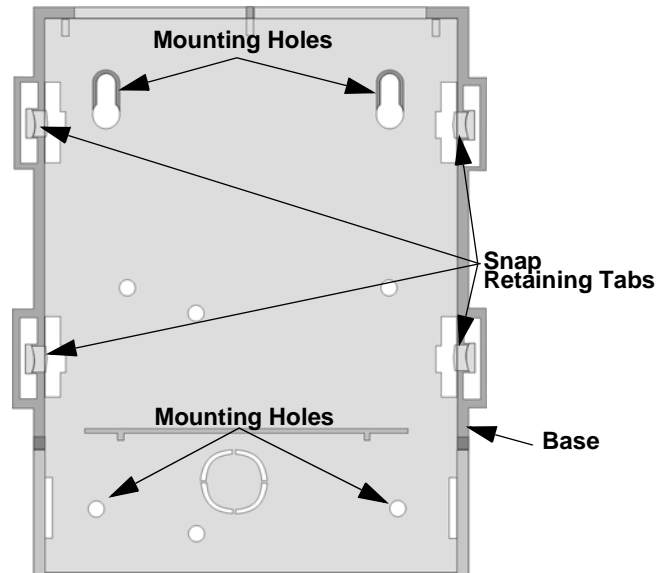

Figure 1: 5824 Circuit Board And Plastic Base

- Mount the plastic base.
- Replace the circuit board in the plastic base.

Note: It may be necessary to connect the wiring to the circuit board before the board is replaced in the base. See Section 3.14.5.2.

- Connect the 5824 to the 5208.
- Set the device ID (see Section 3.14.1). See also Figure 3-25 for ID selector switch location.

3.14.5.2 5824 SBUS Connections

Figure 3-24 illustrates how the 5824 connects to the 5208 control panel.

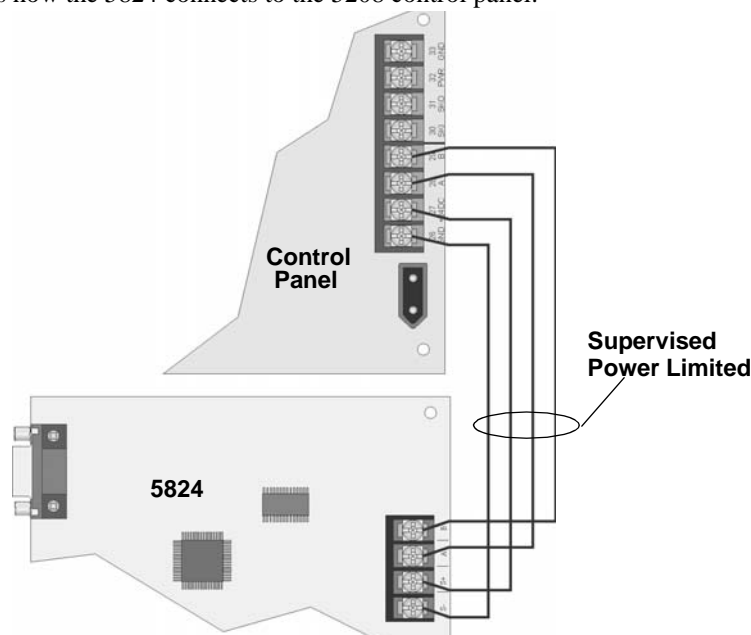

Figure 3-24 5824 Connections

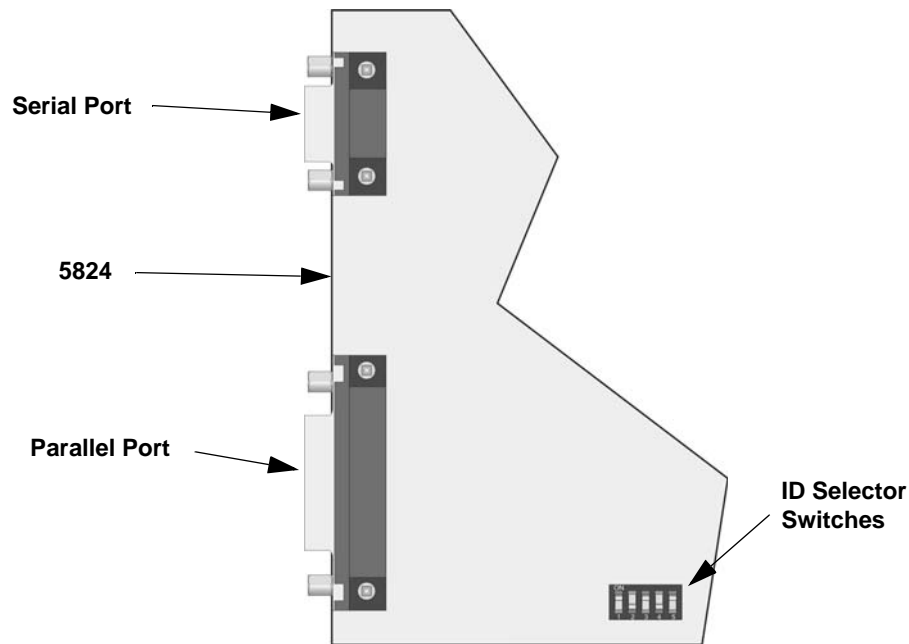

Figure 3-25 Model 5824 Serial/Parallel Port, and ID Selector Switch location

3.15 Special Applications

3.15.1 Model 5220 Direct Connect Module

The 5220 Direct Connect module can be used with the SK-5208 to meet NFPA 72 standards. The 5220 requires four connections to the SK-5208 and provides outputs for city box and polarity reversal applications. The 5220 cannot be used for sprinkler supervisory.

The 5220 provides a current that reverses polarity during alarm or removes current during a trouble condition. Maximum voltage 27.3 VDC.

*Note: The 5220 Direct Connect Module will activate for alarm and trouble conditions during a Walk Test. To disable alarm activation during Walk Test, bypass the NAC programmed for Direct Connect before entering the Walk Test mode. To bypass the NAC, press; 10 + NAC# + * + Code (repeat to un-bypass NAC). The Direct Connect relay will indicate trouble until the NAC is un-bypassed.*

3.15.1.1 City Box Connection

This section describes how to connect the SK-5208 to a municipal fire alarm box or “city box” as required by NFPA 72 Auxiliary Protected Fire Alarm systems for fire alarm service. The city (master) box is an enclosure that contains a manually operated transmitter used to send an alarm to the municipal communication center which houses the central operating part of the fire alarm system.

The maximum coil and wire resistance (combined) must not exceed 30 ohms.

To install the 5220 for city box connection:

1. Locate the knockout on the right side of the SK-5208 cabinet to connect the 5220 using a short piece of conduit (must not exceed 20 feet in length).
2. Wire the 5220 to the SK-5208 as shown in Figure 3-26. This drawing also shows how to connect the city box coil to terminals 3 and 4 on the 5220.

3. Program NAC #4 to be direct connect from the NAC Options menu. Relay #4 will automatically be configured to indicate system troubles.

Note: It is not possible to reset the remote indication until you clear the condition and reset the SK-5208.

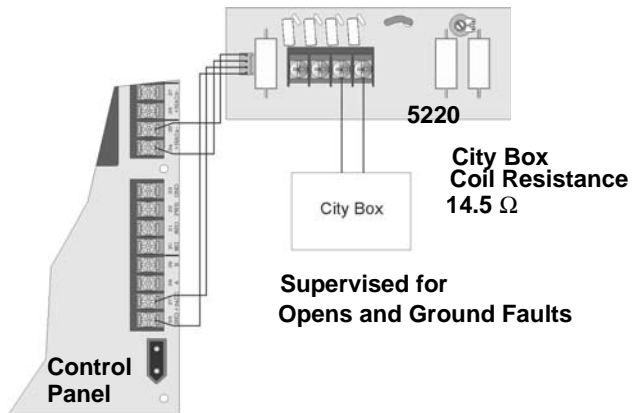

Figure 3-26 City Box Connection

3.15.1.2 NFPA 72 Polarity Reversal

When the 5220 is wired and programmed for polarity reversal, it reports alarm and trouble events to a remote site. Alarms will override trouble conditions and it will not be possible to reset the remote indicator until the condition is cleared and the SK-5208 panel is reset.

If an alarm condition occurs, the alarm relay will close, overriding the trouble condition.

To install the 5220 for polarity reversal, follow the steps below:

1. Locate the knockout on the right side of the SK-5208 cabinet to connect the 5220 using a short piece of conduit (must not exceed 20 feet in length).
2. Wire the 5220 to the SK-5208 using the four-wire pigtail provided as shown in Figure 3-27 (next page). This diagram also shows how to connect the 5220 to the remote indicator.
3. Program one of the notification circuits to be Direct Connect (Figure 3-27 uses NAC 4 and Relay 4). The relay and NAC circuits are paired when selected as direct connect. For example, if NAC 4 is programmed as Direct Connect then relay 4 used for the trouble output. Do not program the NAC for Silence or Supervision (NACs with EOL).

- If necessary, adjust circuit current using potentiometer R10 on the 5220 board. Normal circuit current is 4-to-8 mA with a 1k ohm remote station protected premise unit. Maximum circuit resistance is 3k ohm.

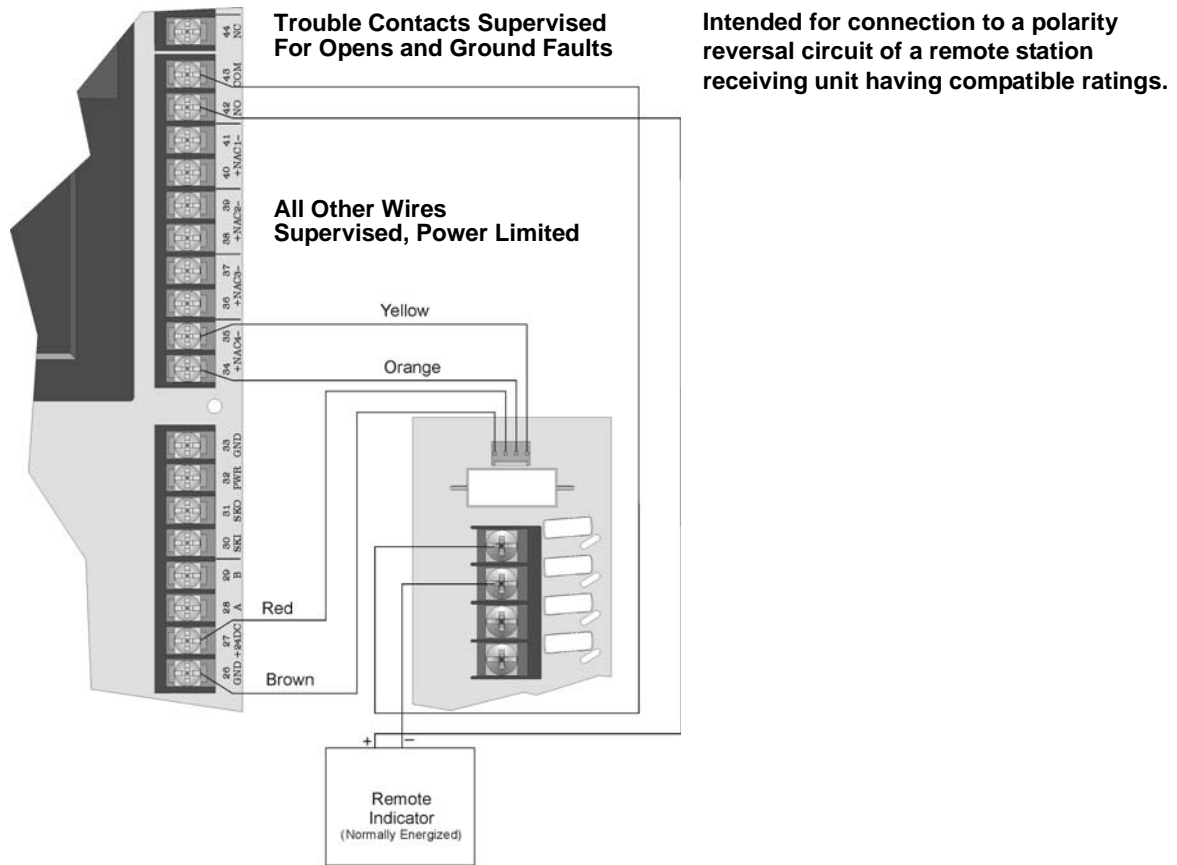

Figure 3-27 Polarity Reversal Connection

3.15.2 Keltron 95M3158 Tones Transmitter Module

This section of the manual shows the specific connections you will make when wiring the SK-5208 to the Keltron 95M3158 Tones Transmitter Module (3158). Refer to the installation sheet shipped with the 95M3158 for complete information. (Note: The 3158 is not available from Silent Knight.)

Note: The 3158 Keltron Module must be mounted within 3 feet of the control panel and all wiring must be run in conduit. The Keltron Module shall be enclosed in the TBX1 enclosure.

- Wire the 3158 to the SK-5208 as shown in the Figure 3-28.
- Program NAC 4 for Direct Connect (see Section 4.2.4).
- Program NAC 3 for Supervisory (see Section 4.2.4).
- Program NACs 3 and 4 as unsupervised (NACs With EOL). See Section 4.2.4.

- Program NAC 3 cadence as Steady (see Section 4.2.3).

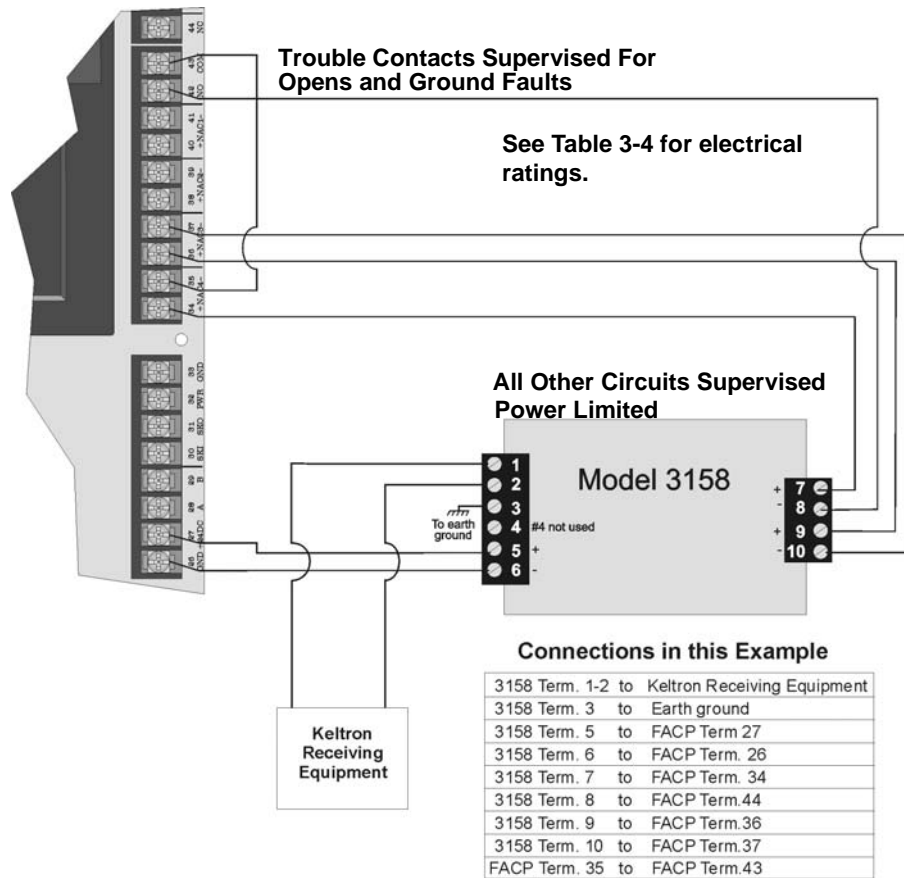

Note: The term FACP Term. refers to terminals on the SK-5208

Figure 3-28 Wiring the Keltron 3158 to the SK-5208

3.15.3 Using a MR-201/T Control Relay From Air Products

When the MR-201/T control relay is wired for polarity reversal, it reports alarm and trouble events to a remote site. Alarms will override trouble conditions and it will not be possible to reset the remote indicator until the condition is cleared and the control panel is reset.

If an alarm condition occurs, the alarm relay will close, overriding the trouble condition.

- Current: 15 mA max.
- Operating Voltage: 24 VDC nominal
- Resistance: 4 K Ω

To install the MR-201/T for polarity reversal, follow the steps below:

1. Wire the MR-201/T as shown in Figure 3-29.

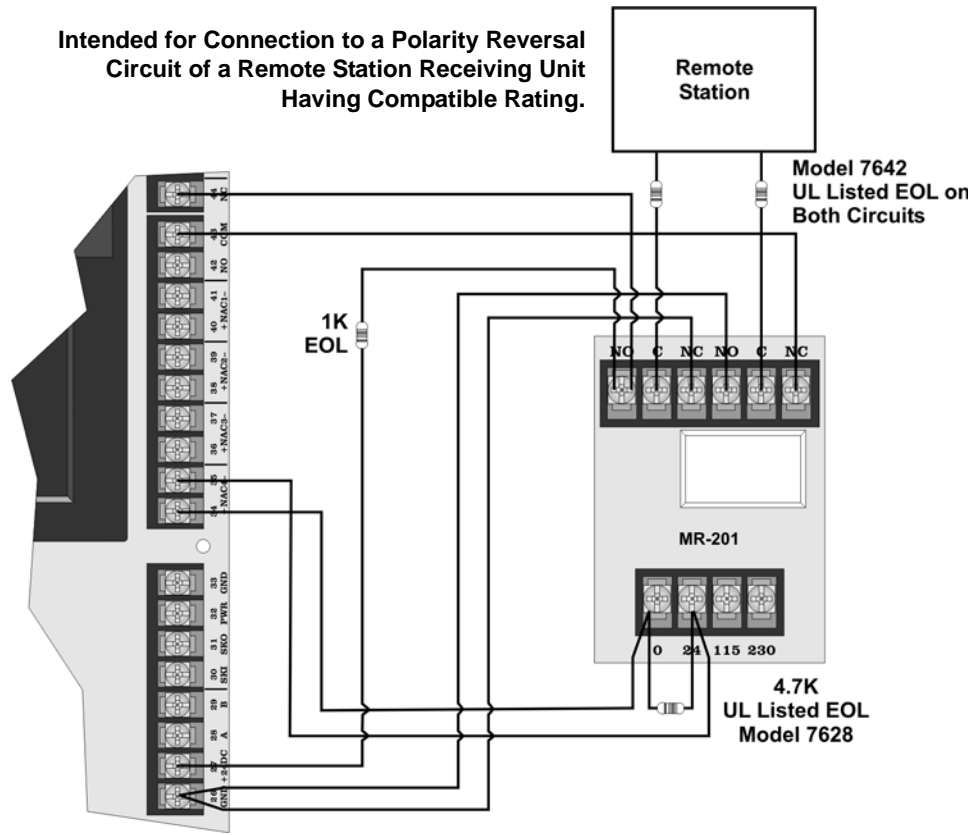

Figure 3-29 Wiring the MR-201/T

2. Program the NAC circuit as a non silence NAC (see Section 4.3).









Section 4

Programming

The SK-5208 control panel can be programmed from either the on-board annunciator or the SK-5235 remote annunciator. You must be in Programming Mode to program the control panel.

4.1 Keypad Operation During Programming









This section describes the function of the buttons on the keypad while in program mode.

Operation/Button	Operation/Description
Enter Step Programming mode	Press 2, 7, ENTER, followed by installer level code (the factory programmed code is 123456 or 5208). See Section 4.2.6 for user code programming information.
Moving through programming	When you have entered programming correctly, the display will show Zone 1 Options. Press  to move to next programming option. See Table 4-4 for list of programming options (column 1) and their menu items (column 2). When the display shows the option you wish to program press ENTER to program items in this option. If you receive a trouble beep and the message TRY AGAIN appears you are not using an installer level code.
Exit Step Programming	Press RESET. You are prompted to save programming changes. The default is No. Press the up or down arrow to select Yes to save programming changes. Press Enter to complete the save and return to normal operation mode.
Down Arrow 	Accepts the entered data and scrolls down to the next menu item.
Enter Button 	Accepts the entered data and scrolls down to the next menu item.
Left Arrow 	Scrolls backwards through the programmable items list for the currently selected option.
Right Arrow 	Scrolls forward through the programmable options list or choices for an the selected item.
Silence Button 	Enables extended programming list so you can scroll through lists of items that have multiple components such as, Zone 1 -30. See Section 4.1.2 for an example.
Up Arrow 	Accepts the entered data and scrolls up to the next menu item.
* Button 	Used as shift key when entering special characters (A, B, C, D, or E characters). See Section 4.1.1 for more information.
# Button 	Clear entry.

4.1.1 Special Characters

Special characters are characters used while dialing such as pause, *, #, or 2nd dial tone. Table 4-1 list the Special characters and what they mean.

Table 4-1: Special Characters

To Enter:	Press	LCD Display
Pause	 	A
*	 	B
#	 	C
2nd Dial Tone	 	D

4.1.2 Enabling Extended Programming List

While programming there are several programming options that have multiple components that can be programmed within that menu item, such as Zones, NAC Cadence, User Codes, Accounts, etc. However when you scroll through these options only the first one may be displayed (see Figure 4-1). In order to view and program subsequent items the Silence button must be pressed. This enables you to move through the other Zones, NAC Cadence, etc.

Example:

If the Zone 1 Options is displayed (see Figure 4-1) and you want to program zone 2 options, press the SILENCE button.

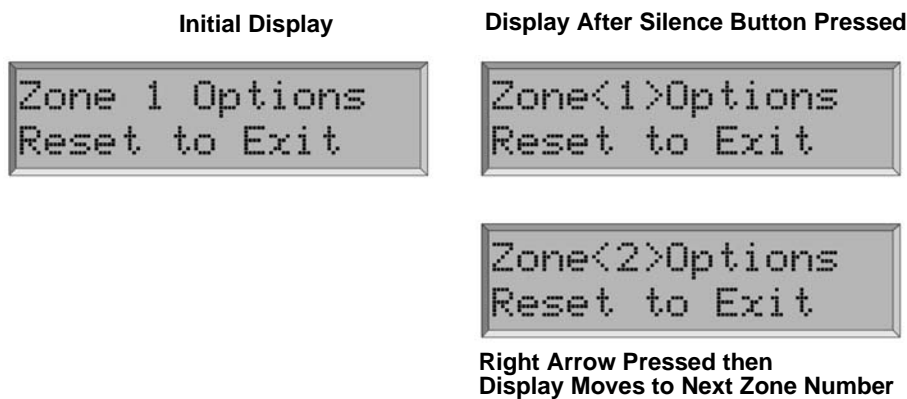

Figure 4-1 Extended Programming List Access Example

The display will add brackets around the zone number (see Figure 4-1). To move to the next zone number press the right arrow to go forward through the zone numbers or the left arrow to go backward through the zone numbers. Press the Silence button again to remove the bracket and lock the menu on this Zone number, NAC number, or Relay, etc.

This Feature works for the following programming options: Zone Options, NAC Cadence, User Codes, Accounts, Line Options, and SK-5280 Options.

4.2 Programming Flow

Figure 4-2 provides an overview of the programming menu flow. Figure 4-3 through Figure 4-13 illustrate the programming flow within each option. The arrows indicate how to maneuver through programming.

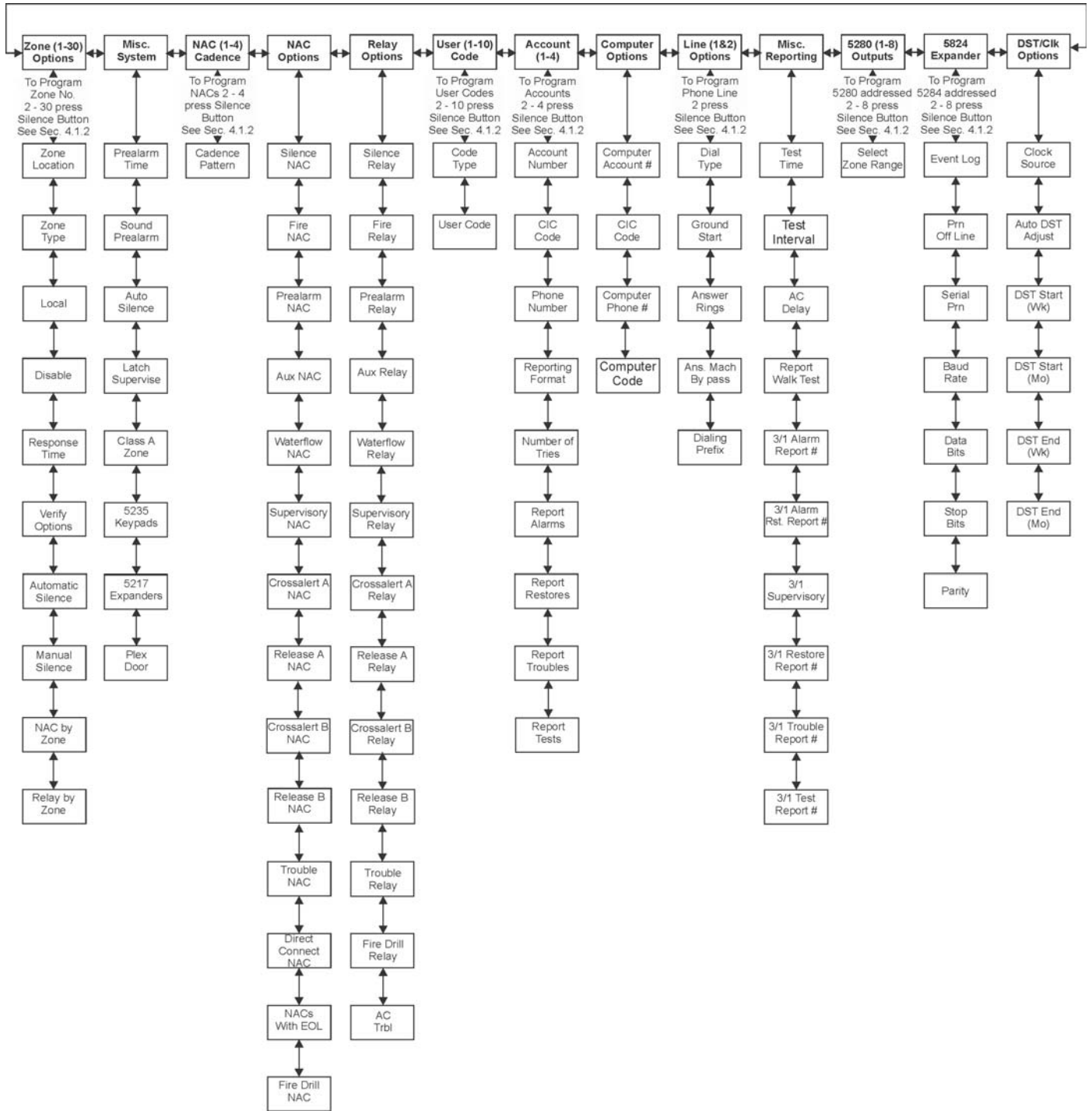

Figure 4-2 Programming Overview Flow Chart

4.2.1 Zone Options

Figure 4-3 illustrates, in more detail, the programming flow when in the zone options menu.

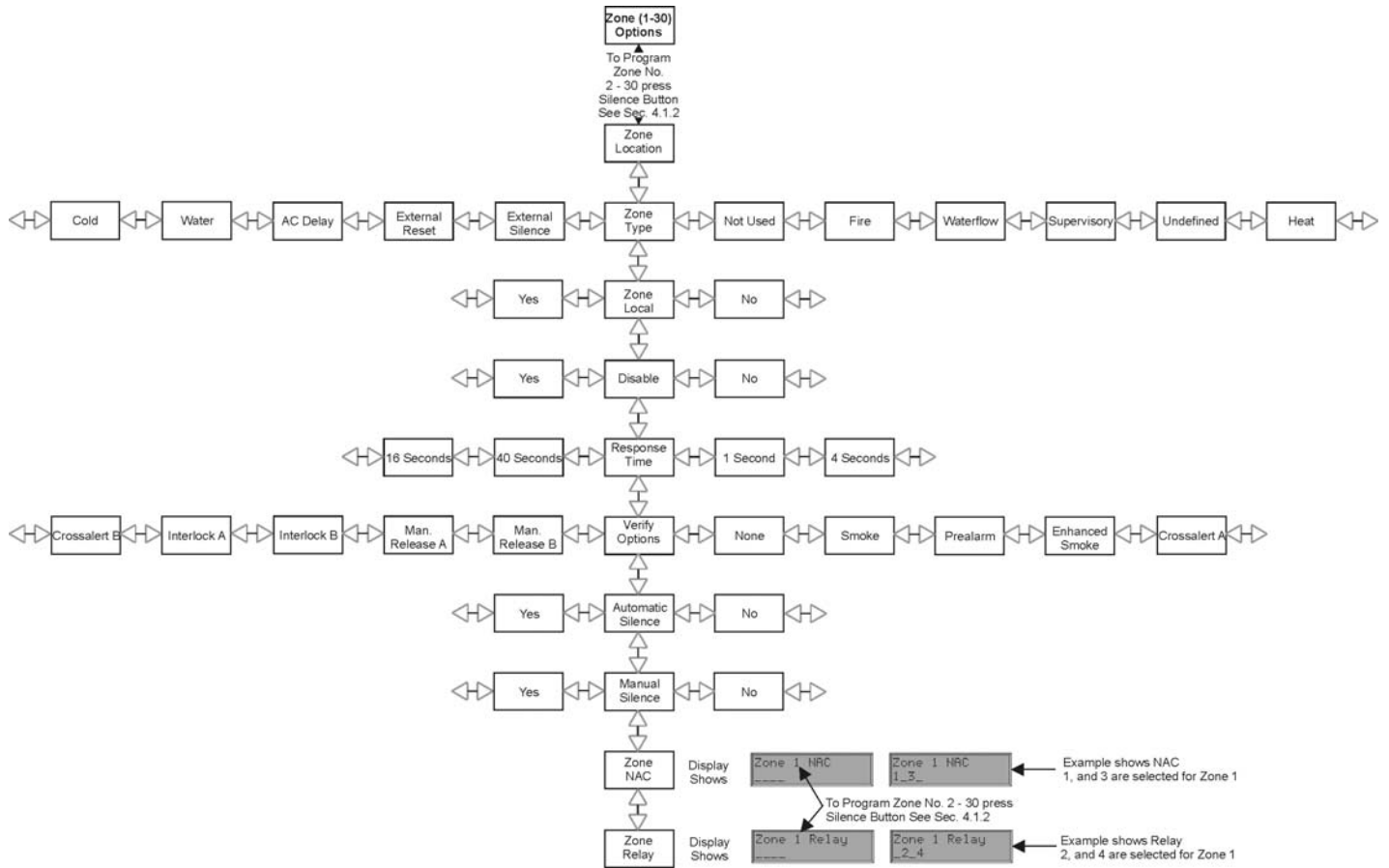

Figure 4-3 Zone Options

4.2.2 Misc System Option

Figure 4-4 illustrates, in more detail, the programming flow when in the misc system menu.

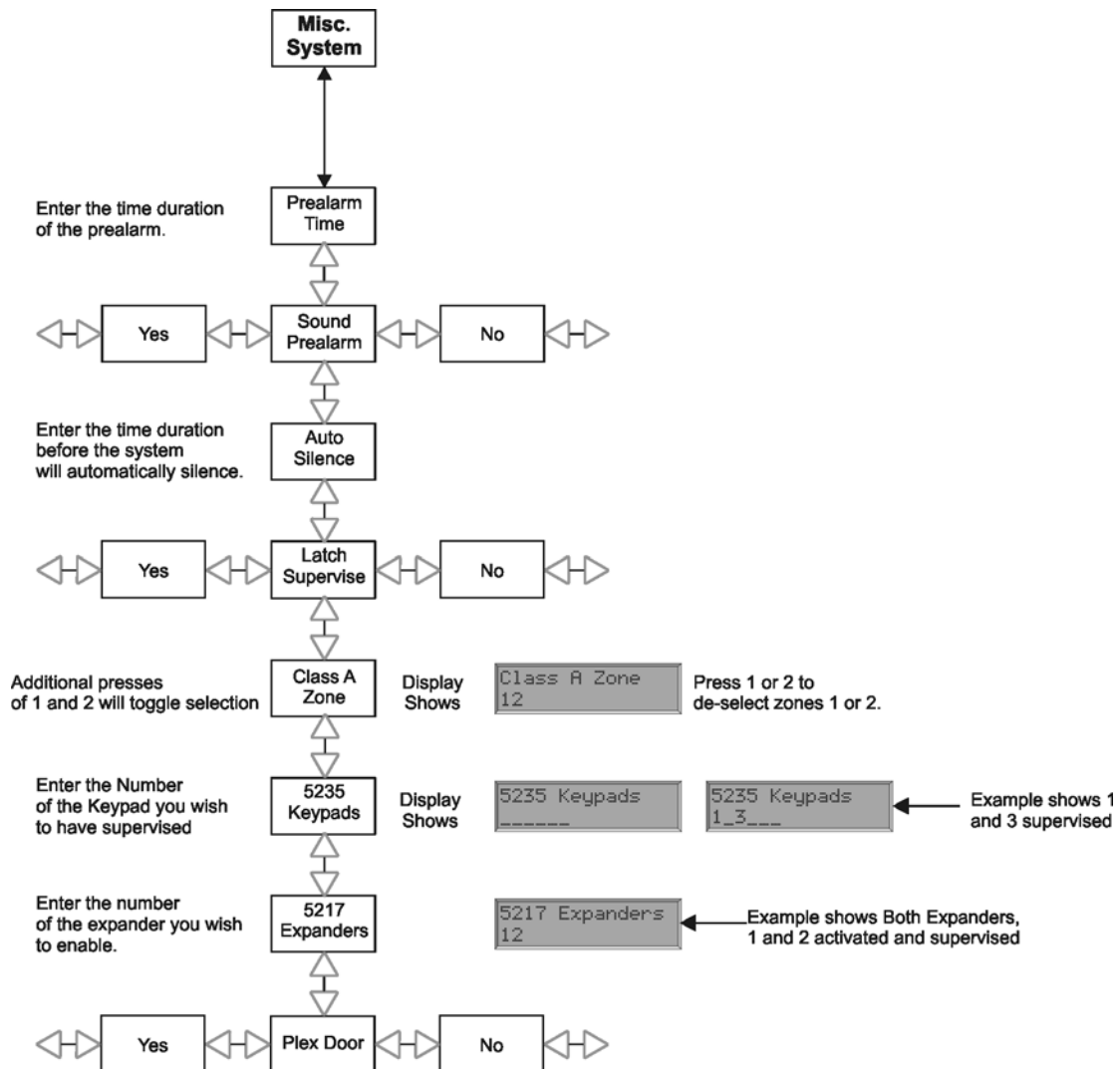

Figure 4-4 Miscellaneous System Options

4.2.3 NAC Cadence

Figure 4-5 illustrates, in more detail, the programming flow when in the NAC cadence menu.

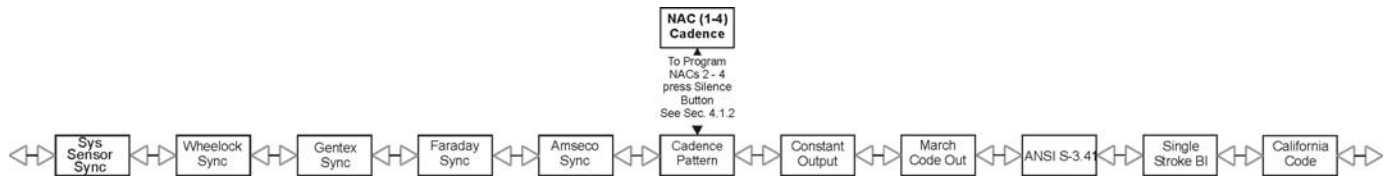

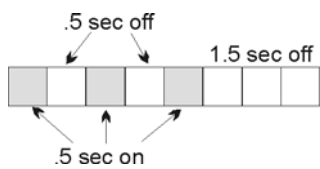
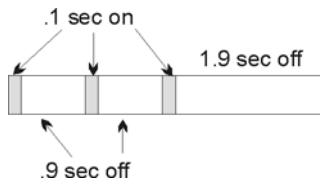



Figure 4-5 NAC Cadence

4.2.3.1 Cadence Patterns

The cadence patterns shown in Table 4-2 can be selected for NAC outputs. Each NAC can select an output pattern. Special cadence patterns can be selected for fire drill or an auxiliary input switches used with the system.

Table 4-2: Cadence Patterns

#	Name	Pattern Description (Patterns repeat until condition is cleared)
1	Constant Output	Continuous sound
2	March Code Output	 .5 sec on .5 sec off
3	ANSI S-3.41 Code Output	
4	Single Stroke BI	
5	California Code	
6	System Sensor Sync.	Provides Synchronization for visual and audible devices.
7	Wheelock Sync.	
8	Gentex Sync.	
9	Faraday Sync.	
10	Amseco Sync.	

4.2.4 NAC Options

Figure 4-6 illustrates, in more detail, the programming flow when in the NAC options menu.

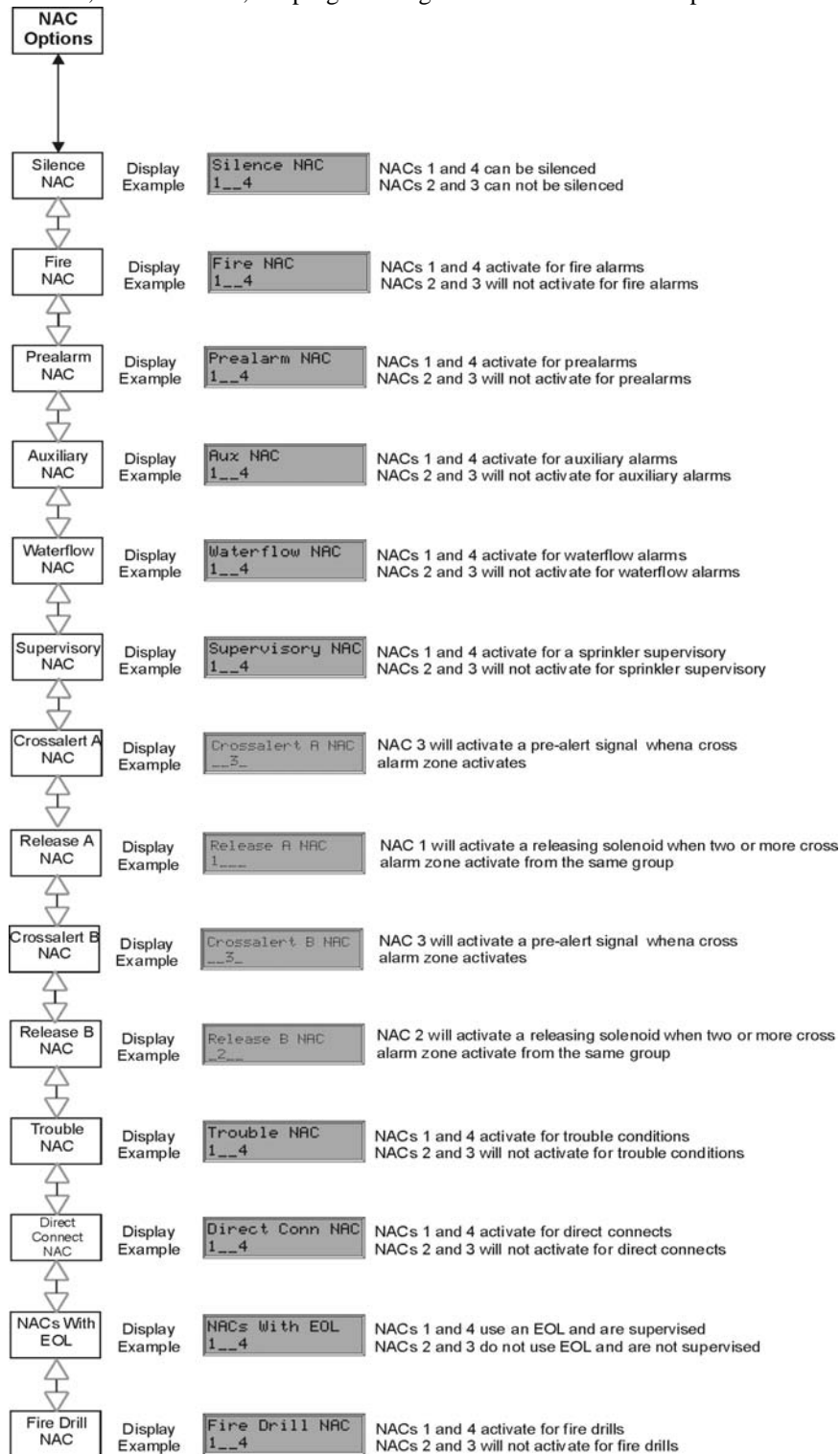

Figure 4-6 NAC Options Programming Menu

4.2.5 Relay Options

Figure 4-7 illustrates, in more detail, the programming flow when in the relay options menu.

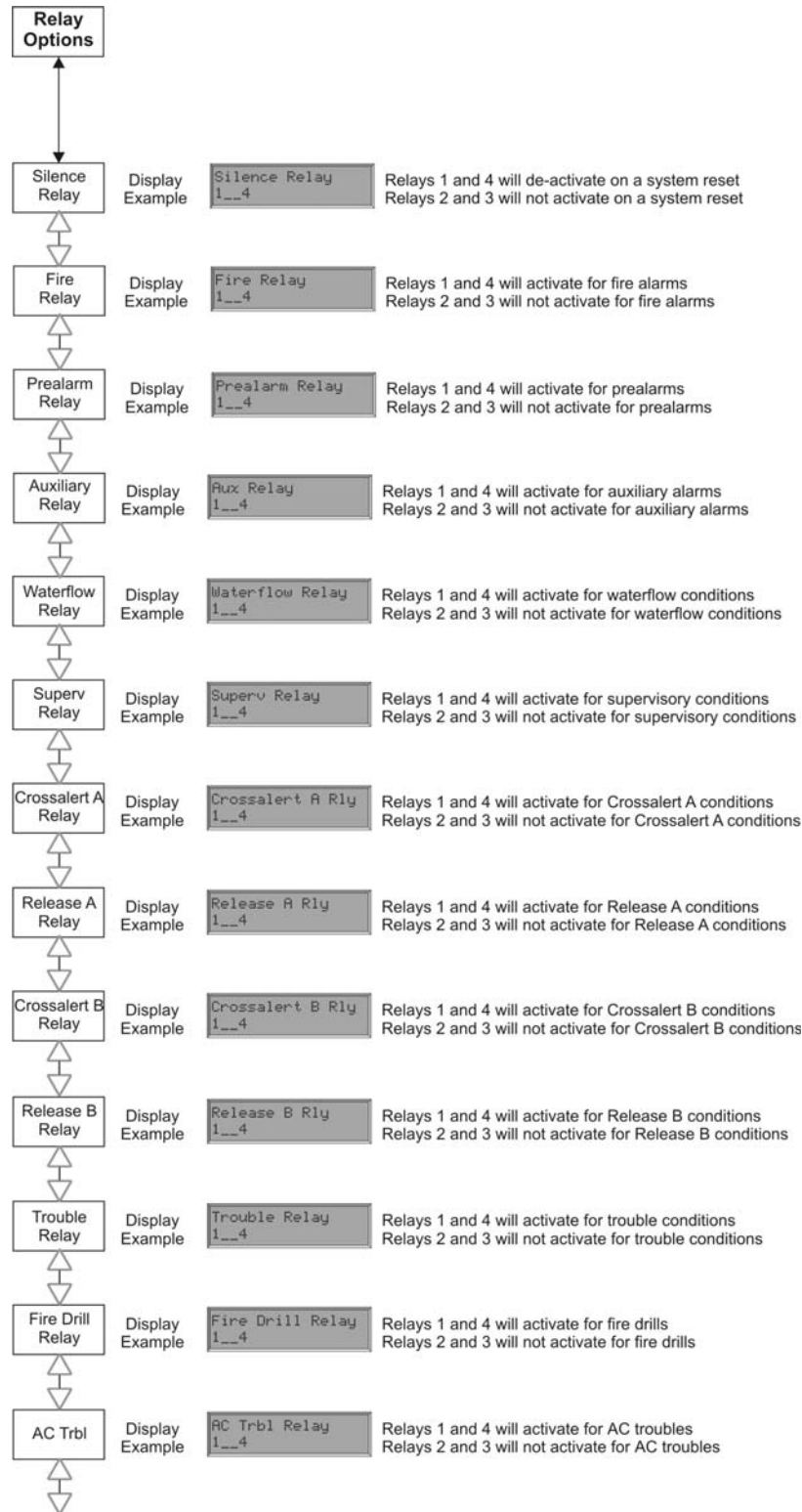

Figure 4-7 Relay Options Programming Menu

4.2.6 User Code

Figure 4-8 illustrates, in more detail, the programming flow when in the user code menu.

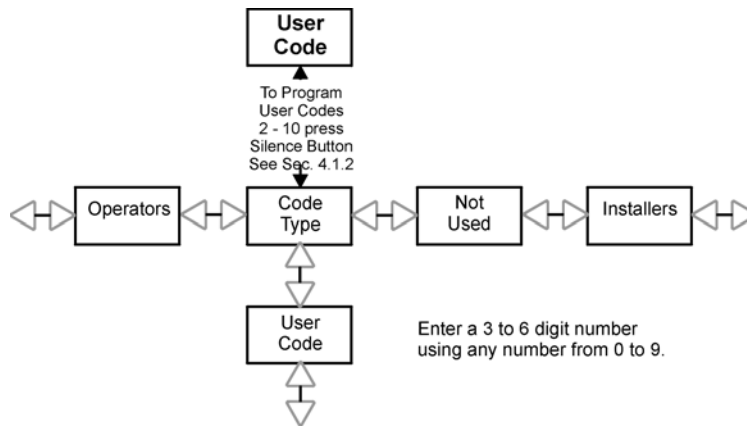

Figure 4-8 User Code Programming Menu

4.2.7 Account

Figure 4-9 illustrates, in more detail, the programming flow when in the account menu.

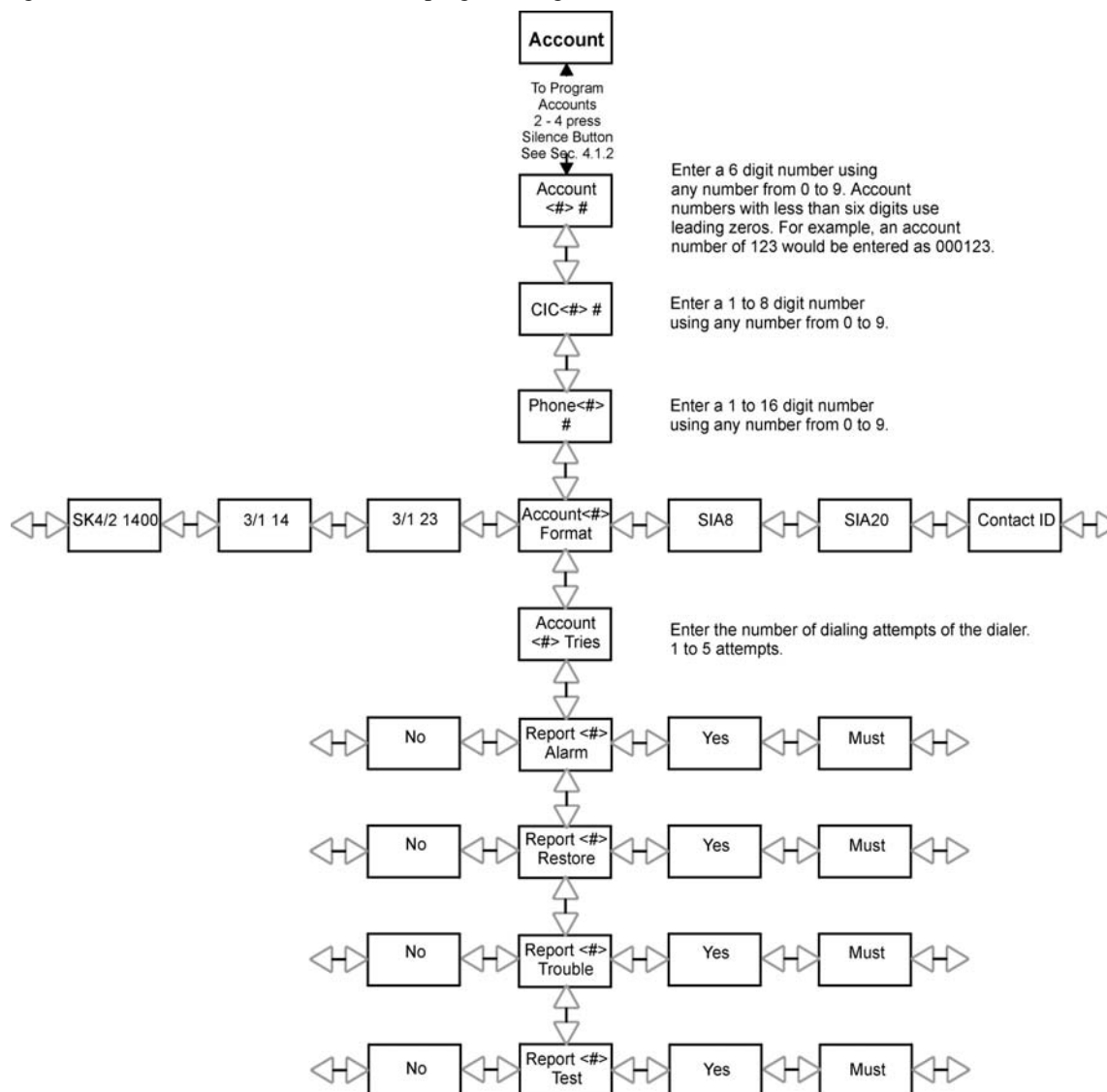

Figure 4-9 Account Programming Menu

Must	The dialer MUST report events in this family to this account. Selecting Must makes an account a primary reporting account. The dialer will try to report the event to the primary account until it exceeds the "Account Tries" value. When the dialer has exceeded the Account Tries retry limit, it will switch to a backup account (a "Can Report" or "Yes" account, see below). If the dialer cannot report the event to any of the backup accounts, it will return to the primary account and repeat the process until it exceeds the a total of 10 attempts. When the Account Tries limit is exceeded, an Account Trouble condition is generated and a local trouble will sound.
Yes	Can Report. Selecting Y makes this a backup account for this event family. The dialer will report to this account only if it was previously unable to report the event to a Must account.
No	No events in this family will ever be reported to this account.

Note: CIC and Phone number can also use special characters as described in Section 4.1.1.

4.2.8 Computer Options

Figure 4-10 illustrates, in more detail, the programming flow when in the computer options menu.

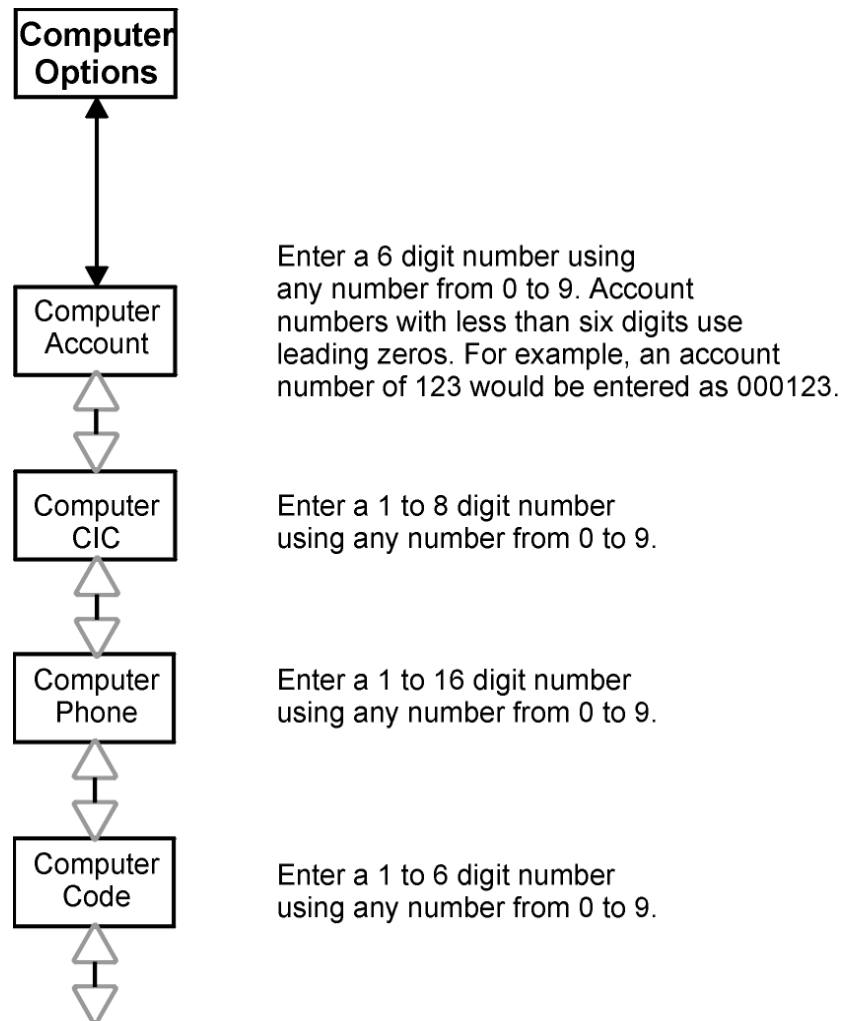

Figure 4-10 Computer Options Programming Menu

Note: Computer CIC & Phone can also use special characters as described in Section 4.1.1.

4.2.8.1 Computer Code

In order to remote download to a control, the computer code programmed in the panel, and the computer code used in the downloading software must match.

! Important!

Remote downloading can only be used for Central Station Signaling Services, if this system does not meet Central Station Signaling requirements, this feature must be set to zero.

4.2.9 Line Options

Figure 4-11 illustrates, in more detail, the programming flow when in the line options menu.

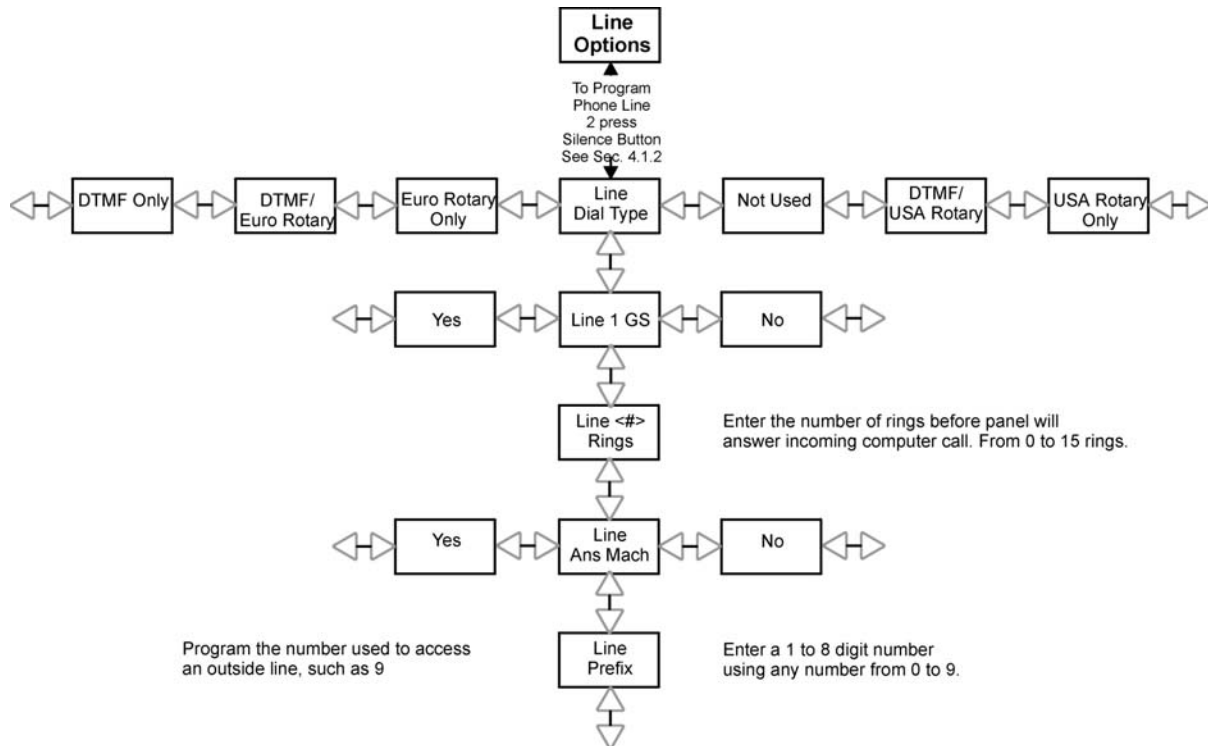

Figure 4-11 Line Options Programming Menu

Note: Line prefix can also use special characters as described in Section 4.1.1.

4.2.10 Misc Reporting

Figure 4-12 illustrates, in more detail, the programming flow when in the miscellaneous reporting menu.

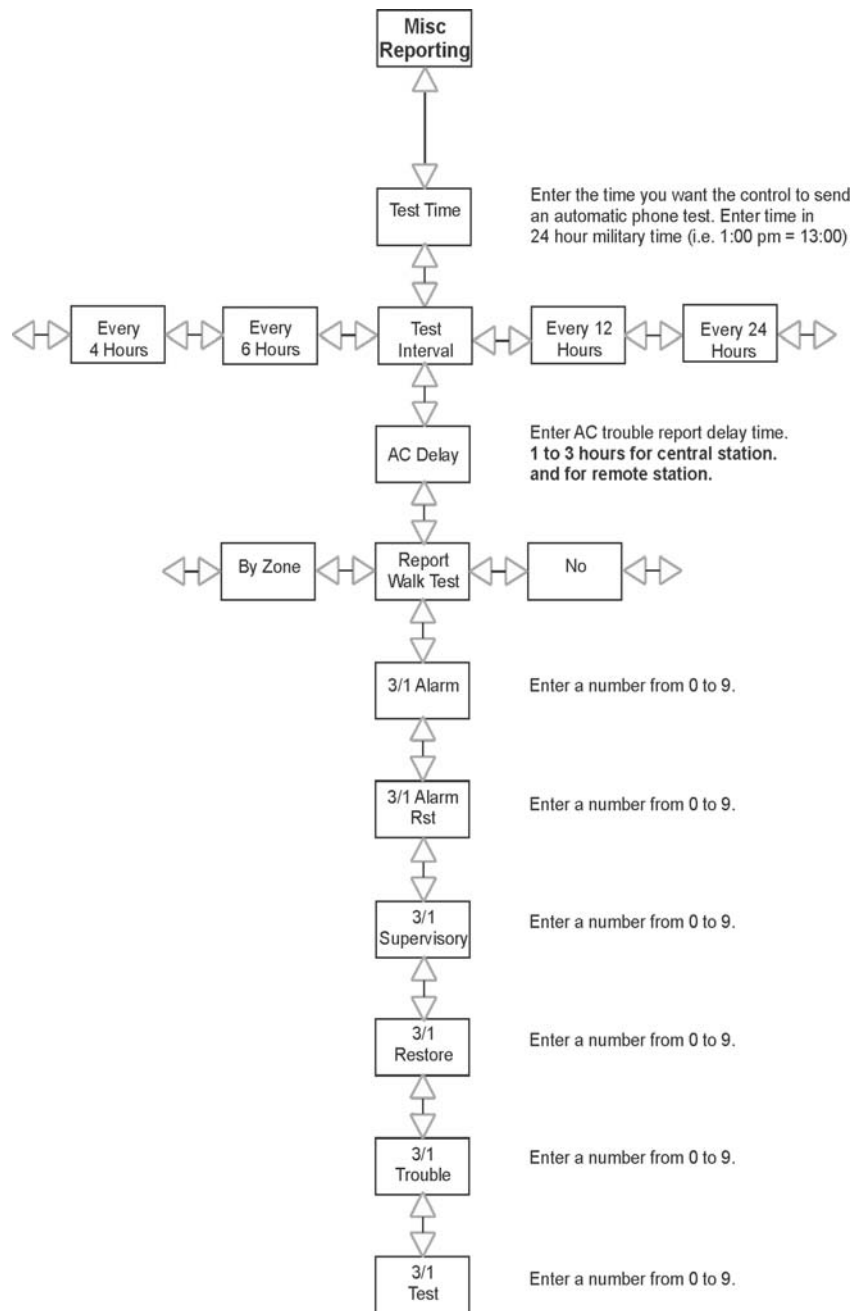

Figure 4-12 Misc Reporting Programming Menu

4.2.11 5280 Outputs

Figure 4-13 illustrates, in more detail, the programming flow when in the SK-5280 outputs menu.

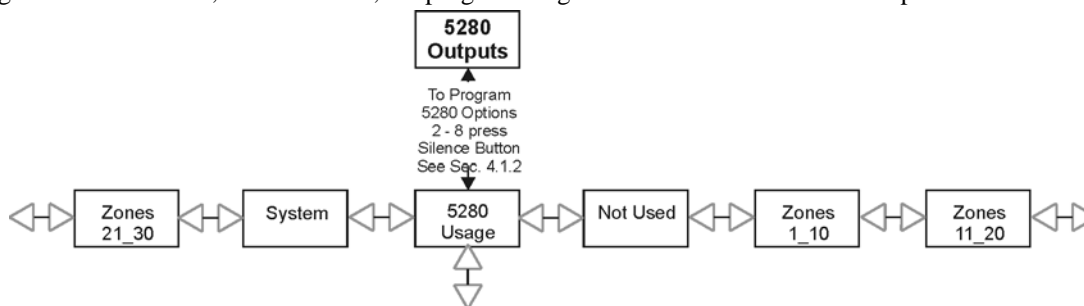

Figure 4-13 5280 Outputs Programming Menu

If Zones 1-10 is selected then the SK-5280 will output when alarms and troubles occur for zones 1 through 10. If Zones 11-20 is selected then SK-5280 will output when alarms and troubles occur for zones 11 through 20. If Zones 21-30 is selected then the SK-5280 will output when alarms and troubles occur for zones 21-30.

If System is selected then the SK-5280 will output as shown in Table 4-3 for the following system conditions:

Table 4-3: System Outputs

SK-5280 Output Terminal	Output For:
A1	Fire Alarm
A2	Waterflow Alarm
A3	Supervisory
A4	Aux Alarm
A5	Prealarm
A6	Trouble
A7	Communications Fail
A8	Communicating
A9	Alarm Silenced
A10	Trouble Silenced
T1	Low AC
T2	Low Battery
T3	Relay 1 Active
T4	Relay 2 Active
T5	Relay 3 Active
T6	Relay 4 Active
T7	NAC 1 Active
T8	NAC 2 Active
T9	NAC 3 Active
T10	NAC 4 Active

4.2.12 5824 Expander Options

Figure 4-14 illustrates, in more detail, the programming flow for the 5824 serial/parallel module.

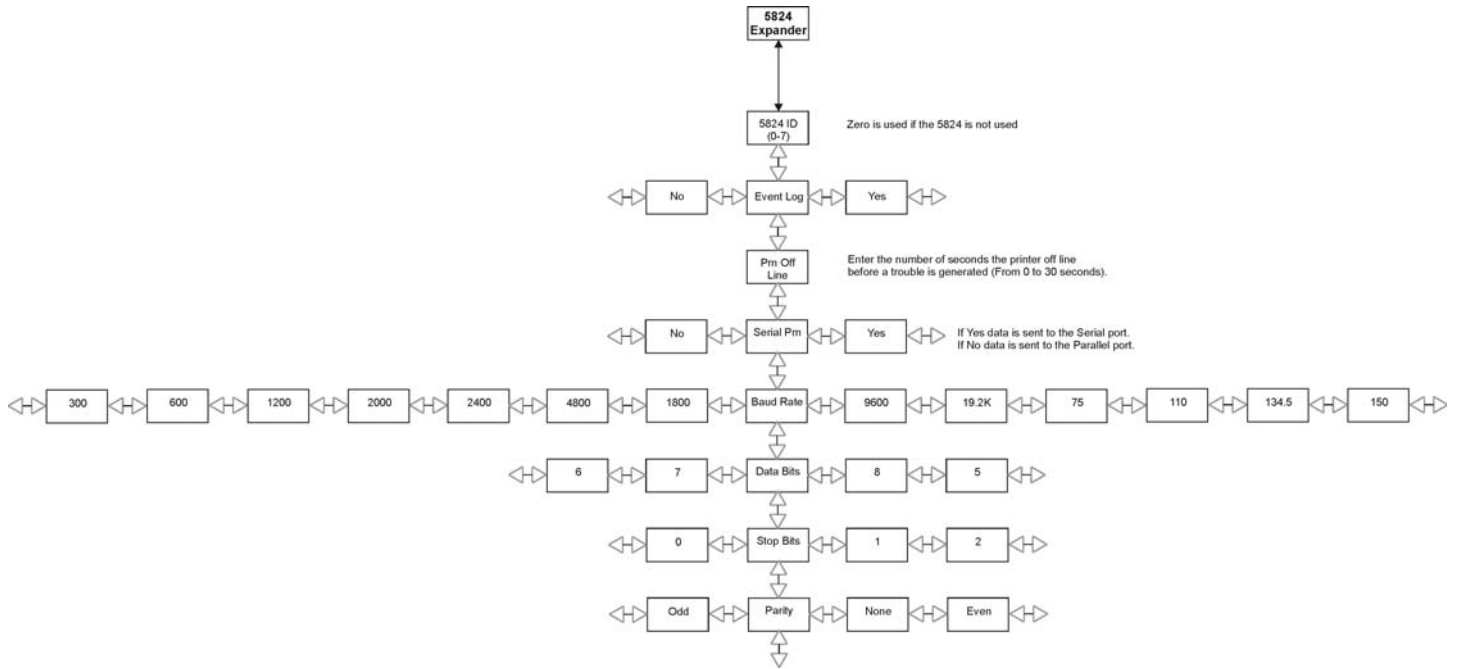

Figure 4-14

Figure 4-15 5824 Programming Options Flow Chart

4.2.13 DST/Clk Options

Figure 4-16 illustrates the programming flow for the Daylight Saving Time (DST) and clock source options.

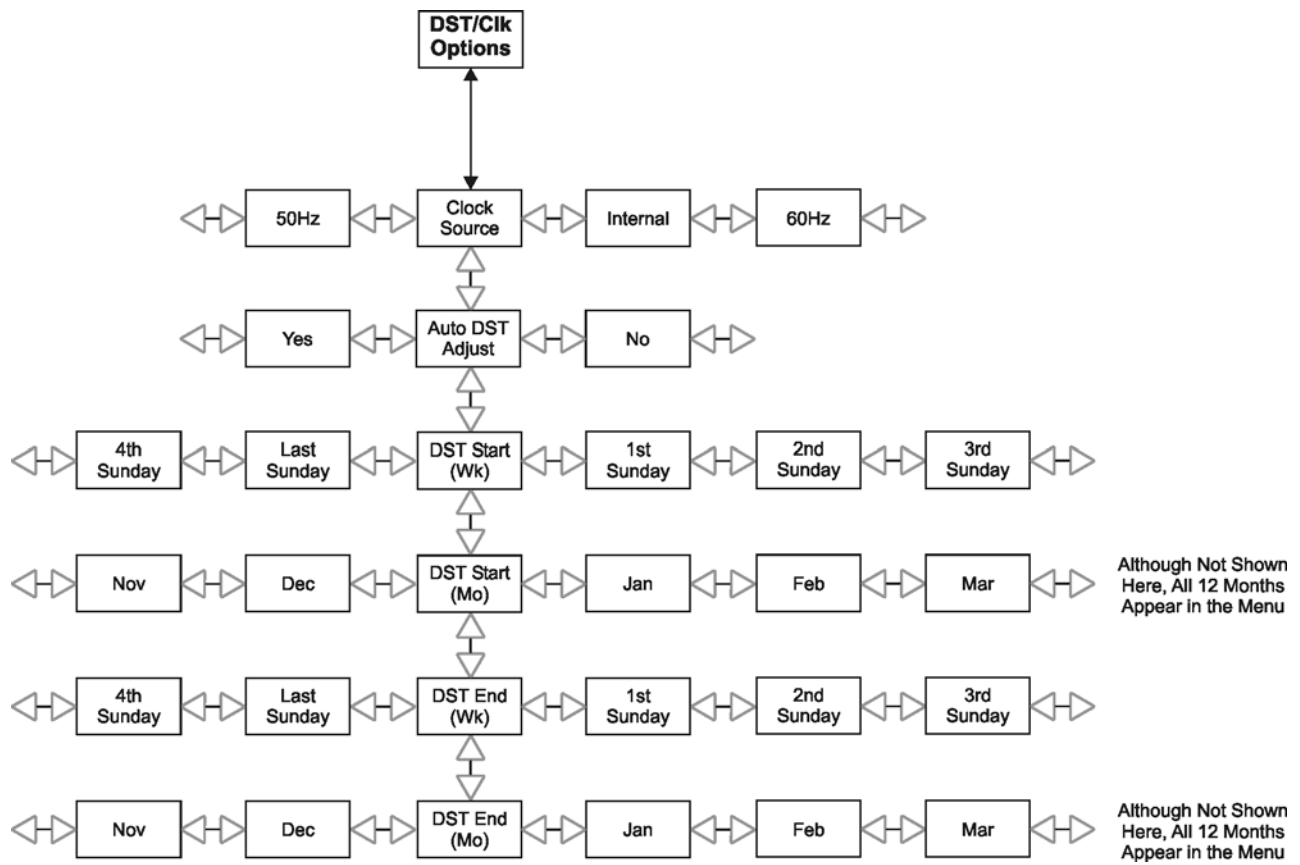

Figure 4-16 DST/Clk Options Flow Chart

4.3 Programming Options

Table 4-4 list all the programming options and the items that can be modified within those programming option menus.

Note: Programming options that have a # in the Programming Options column have multiple programmable components. See Section 4.1.2 for additional information.

Table 4-4: Programming Options

Programming Option	Menu Item	Choices	Default	Comments	
Zone (1-30) # Options	Zone # Location			Programmable through SKSS downloading software. To program through On-board or remote annunciator: 1. Press * to activate. 2. Press Up or Down arrow to move through character set. 3. Press Left or Right arrow to move cursor to desired character location. 4. Repeat steps 2 and 3 until location name is entered. 5. Press Enter when the desired location name is complete.	
	Zone # Type	Not Used			
		Fire		X	
		Waterflow			
		Supervisory			
		Undefined			
		Heat			
		Cold			
		Water			
		AC Delay			Will generate an AC Trouble for either an open or shorted input. The report to the receiver will be delayed until the AC Delay timer expires. (See Section 4.2.10 for AC Delay Time programming.)
		Ext. Reset			A shorted input will reset active alarms. This type of zone is local only. No troubles will be reported to the central station receiver.
	Ext. Silence			A shorted input will silence alarms and troubles. This type of zone is local only. No troubles will be reported to the central station receiver.	
	Zone # Local	No		X	Zone will report when activated.
		Yes			Local Zone, will not report when activated.
	Zone # Disable	No			Zone cannot be bypassed.
		Yes		X	Zone can be bypassed.
	Zone # Response	1 Sec		X	
		4 sec			
		16 sec			
		40 sec			

Table 4-4: Programming Options

Programming Option	Menu Item	Choices	Default	Comments
Zone (1-30) # Options	Verify # Options	None	X	Note: Alarm verification feature must not be used if the FACP is being used for releasing.
		Smoke		Smoke verification for zones with 2- or 4-wire detectors. Do not use any other type of device on this circuit if Smoke Verification is selected.
		Prealarm		Activated zone will start a prealarm timer that counts down from a user programmed value (see Section 4.2.2 for prealarm time programming). If the timer reaches zero before the panel is reset, a general alarm will then be sounded.
		Crossalert A		See Section 5.5.
		Crossalert B		
		Interlock A		
		Interlock B		
		Manual Release A		See Section 5.5.
		Manual Release B		
	Enhanced Smoke		Smoke verification for zones with 2-wire detectors and contact type devices, such as pull stations, used on the same circuit. If the alarm current is greater than 78 mA, the smoke verification cycle will not occur.	
	Zone # Auto Sil	No	X	Alarm sounds for this zone cannot be automatically silenced.
		Yes		Alarm sounds for this zone can be automatically silenced.
	Zone # Man Sil	No		Alarm sounds for this zone cannot be manually silenced.
		Yes	X	Alarm sounds for this zone can be manually silenced.
Zone # NAC	----		Select the number of each NAC to operate with this zone in alarm.	
Zone # Relay	----		Select the number of each Relay to operate with this zone in alarm.	
Misc System	Prealarm Time	Enter a value from 0 to 60	40 seconds	Enter time duration for prealarm verification.
	Sound Prealarm	No		No on-board or 5235 remote PZT sound for prealarms.
		Yes	X	5235 and on-board PZTs will sound for prealarms.
	Auto Silence	Enter a value from 0 to 60	8 minutes	This feature selects the time in minutes in which the NAC will automatically silence. 0 = no automatic silence
	Latch Supervise	No	X	Supervisory type zones will self restore.
		Yes		Supervisory type zones must be reset after any supervisories conditions.
	Class A Zone	1	Class A.	
2				
5235 Keypads	-----		Touchpad numbers that are selected here will be supervised.	

Table 4-4: Programming Options

Programming Option	Menu Item	Choices	Default	Comments
Misc System (cont.)	5217 Expanders	1		Enables zones 11-20.
		2		Enables zones 21-30
	Plex Door	No	X	If Yes is selected you are not required to enter a Code for operator level functions, such as Reset, Silence, and Display Event History. Note: If this option is enabled, the PLEX-2 accessory must be installed on the control panel.
		Yes		
NAC (1-4) # Cadence	Constant			Additional cadence patterns are programmable only through down loading software. See also Section 4.2.3.
	March Code			
	ANSI S-3.41 Code	All NACs		
	Single Stroke BI			
	California Code			
	System Sensor Sync.			
	Wheelock Sync.			
	Gentex Sync.			
	Faraday Sync.			
Amseco Sync.				
NAC Options	Silence NAC	----	No NACs selected	If number is selected that NAC may be silenced.
	Fire NAC	1 2 3 4	All NACs selected	If number is selected that NAC will activate for any fire alarm.
	Prealarm NAC	----	No NACs selected	If number is selected that NAC will activate during the prealarm timer countdown.
	Aux NAC	----	No NACs selected	If number is selected that NAC will activate for undefined, heat, cold, and water alarms.
	Waterflow NAC	1 2 3 4	All NACs selected	If number is selected that NAC will activate for waterflow alarms.
	Supervisory NAC	----	No NACs selected	If number is selected that NAC will activate for sprinkler supervisories.
	Crossalert A NAC	----	No NACs selected	If you have a single zone, that is programmed for crossalarm verification, in alarm, all NAC output select for this option will activate.
	Release A NAC	----	No NACs selected	Activates during the group “A” releasing action. This circuit would be connected to a UL listed releasing solenoid. See Table 5-4 for compatible solenoids.
	Crossalert B NAC	----	No NACs selected	If you have a single zone, that is programmed for crossalarm verification, in alarm, all NAC output select for this option will activate.
	Release B	----	No NACs selected	Activates during the group “B” releasing action. This circuit would be connected to a UL listed releasing solenoid. See Table 5-4 for compatible solenoids.
	Trouble NAC	----	No NACs selected	If number is selected that NAC will activate for any trouble condition.
	Direct Conn NAC	----	No NACs selected	for alarms when using the 5220 module for city box or polarity reversal. Corresponding relay number will automatically be selected.
NACs With EOL	1 2 3 4	All NACs selected	If number is selected that NAC output must be supervised with an 4.7 kΩ UL listed EOL.	

Table 4-4: Programming Options

Programming Option	Menu Item	Choices	Default	Comments
NAC Options	Fire Drill NAC	1 2 3 4	All NACs selected	If number is selected that NAC will activate during a fire drill.
Relay Options	Silence Relay	----	No Relays selected	If a relay is selected, that relay can be silenced for Trouble and Supervisory conditions only. (This includes relays programmed for AC Trbl.)
	Fire Relay	1 ---	Relay 1 selected	If a relay is selected, that relay will activate for fire alarm conditions.
	Prealarm Relay	----	No Relays selected	If a relay is selected, that relay will activate for prealarm conditions.
	Aux Relay	----	No Relays selected	If a relay is selected, that relay will activate for Auxiliary conditions.
	Waterflow Relay	----	No Relays selected	If a relay is selected, that relay will activate for waterflow conditions.
	Superv Relay	----	No Relays selected	If a relay is selected, that relay will activate for supervisory conditions.
	Crossalert A Relay	----	No Relays selected	If a relay is selected, that relay will activate for crossalarm conditions.
	Release A Relay	----	No Relays selected	If selected will activate for releasing group "A".
	Crossalert B Relay	----	No Relays selected	If a relay is selected, that relay will activate for crossalarm conditions.
	Release B Relay	----	No Relays selected	If selected will activate for releasing group "B".
	Trouble Relay	--- 4	X	Relay will be activated when no troubles exist and will deactivate when a trouble condition occurs.
	Fire Drill Relay	1 ---	Relay 1 selected	If a relay is selected, that relay will activate for fire drills.
	AC Trbl	----	No Relays selected	If a relay is selected, that relay will be activated when AC is normal and will deactivate when a Low AC condition exists.
User (1-10) # Code	Code # Type	Installers	5208 and 123456	
		Operators	1111	
		Not Used		
	User # Code	Enter 3 to 6 digit number		Enter any value from 001 to 999999.

Table 4-4: Programming Options

Programming Option	Menu Item	Choices	Default	Comments	
Account (1-4) #	Account <#> #	Enter a 6-digits number	1: 105208 2: 205208 3: 305208 4: 405208	Enter any value from 000001 to 999999. Account numbers with less than 6 digits must use leading zeros. For example, if the code 321 is used, it must be entered as 000321.	
	CIC <#> #	Enter up to 8 digits		Carrier Identification Code is the prefix that needs to be dialed before a phone number to access a particular long distance carrier. Use special characters to add pauses, #, *, and “2nd dial tone” characters into the phone number. See Section 4.1.1 for special characters.	
	Phone <#> #	Enter up to 16 digits		See Section 4.1.1 for special characters.	
	Account # Format	SIA8		X	
		SIA20			
		Contact ID			
		SK4/2 1400			
		3/1 1400			
		3/1 2300			
	Account # Tries	1 to 5		3	
	Report # Alarm	No		X	Do not report alarm events.
		Yes			Can report alarm events.
		Must			Must report alarm events.
	Report # Restore	No		X	Do not report alarm restores.
		Yes			Can report alarm restores.
		Must			Must report alarm restores.
	Report # Trouble	No		X	Do not report sprinkler supervisory, system troubles, zone troubles, zone bypasses, and zone restores.
Yes				Can report sprinkler supervisory, system troubles, zone troubles, zone bypasses, and zone restores.	
Must				Must report sprinkler supervisory, system troubles, zone troubles, zone bypasses, and zone restores.	
Report # Test	No		X	Do not report manual test, auto test, downloading pass, downloading fail, data lest, and walk test.	
	Yes			Can report manual test, auto test, downloading pass, downloading fail, data lest, and walk test.	
	Must			Must report manual test, auto test, downloading pass, downloading fail, data lest, and walk test.	
Computer Options	Computer Account	Enter 6-digit number	505208	Enter any value from 000001 to 999999. Account numbers with less than 6 digits must use leading zeros. For example, if the code 321 is used, it must be entered as 000321.	
	Computer CIC	Up to 8 digits.		Carrier Identification Code is the prefix that needs to be dialed before a phone number to access a particular long distance carrier. Use special characters to add pauses, #, *, and “look for second dial tone” characters into the phone number. See Section 4.1.1 for special characters.	
	Computer Phone	up to 16 digits		See Section 4.1.1 for special characters.	

Table 4-4: Programming Options

Programming Option	Menu Item	Choices	Default	Comments
Computer Options	Computer Code	1 to 6 digits	0	The computer code must match the computer code in the remote downloading computer in order to perform a remote download. See also Section 4.2.8.1.
Line (1-2) # Options	Line # Dial Type	Not Used	X	This disables the phone line.
		DTMF/USA Rotary		Attempts 1 through 6 will be DTMF, then the dialer will alternate between Rotary and DTMF for attempts 7 through 10, Rotary Make/Break ratio is 40/60.
		USA Rotary Only		Attempts 1 through 10 will be Rotary only, with a Make/Break ratio of 40/60.
		DTMF Only		Attempts 1 through 10 will be DTMF only.
		DTMF/Euro Rotary		Attempts 1 through 6 will be DTMF, then the dialer will alternate between Rotary and DTMF for attempts 7 through 10, Rotary Make/Break ratio 33/67.
		Euro Rotary Only		Attempts 1 through 10 will be Rotary only, with a Make/Break ratio of 33/67.
	Line # GS	No	X	Yes enables Ground Start phone functions. A ground start relay (Model 5211) is required if this feature is enabled (see Figure 3-2).
		Yes		
	Line # Rings	0 - 15	Line 1: 2 Line 2: 10	Number of rings before the panel will answer an incoming telephone call.
	Line # Ans Mach	No	X	This feature is used in installations where an answering machine is on the same phone line that the control panel is on. The answering machine may interfere with a computer download.
Yes			When enabled (Yes) the computer calls the control panel and the phone line rings twice, hangs up and calls again (within 10 to 60 seconds). When the control panel see two more rings on the phone line it will answer and acknowledge the calling computer.	
Line # Prefix	Up to 8 digits		See Section 4.1.1 for special characters.	
Misc Reporting	Test Time	00:00 - 23:59	12:00	Selects the time of day the control will send an automatic test signal to a central station receiver.
	Test Interval	Every 4		Selects the period to which the system performs an Automatic Self Test, keyed off the Test Time.
		Every 6		
		Every 12		
		Every 24	X	
	AC Delay	0-30 Hours	2	Selects the delay time (in hours) before the control will report an AC power loss to the central station.
Report Walk Test	No	X	No zone information will be reported just test begin and test end.	
	By Zone		Test begin, test end, and all events in between will be reported to central station.	

Table 4-4: Programming Options

Programming Option	Menu Item	Choices	Default	Comments	
Misc Reporting	*3/1 Alarm	0 - 9 * Event code for 3/1 and 4/2 reporting formats.	0	Alarms for Fire, Waterflow, Undefined, Heat, Cold, and Water events.	
	*3/1 Alarm Rst		2	Alarms restores for Fire, Waterflow, Undefined, Heat, Cold, and Water events.	
	*3/1 Supervisory		6	Sprinkler supervisories.	
	*3/1 Restore		7	Restore reports for Troubles, Supervisories, and unbypasses. The only exceptions are the restores listed as alarm restores.	
	*3/1 Trouble		8	All system and zone troubles, and zone/NAC bypasses, and NACs troubles.	
	*3/1 Test		9	All test events.	
5280 (1 - 8) # Outputs	5280 #	Not Used	X		
		Zones 1_10			
		Zones 11_20			
		Zones 21_30			
		System			
5824 Expander	5824 ID	0 - 7	0	Sets the serial bus address for the 5824. Use a 0 to disable this feature.	
	Event Log	Yes	X	If yes then all events are sent to the printer.	
		No			
	Prn Off Line	0 - 30 Seconds	20	Selects the number of seconds the printer can be off line before a trouble is generated.	
	Serial Prn	Yes	X	If yes is selected then data is sent to the serial port.	
		No		If no is selected then data is sent to the parallel port.	
	Baud Rate		9600	X	Select the Baud rate at which your printer requires to communicate properly. Consult installation manual for the printer you are using.
			19.2K		
			75		
			110		
			134.5		
			150		
			300		
			600		
			1200		
			2000		
			2400		
	4800				
	1800				
	Data Bits		8	X	Select the number of data bits that your printer requires for proper communication. Consult installation manual for your printer.
5					
6					
7					
Stop Bits		1	X	Select the number of stop bits that your printer requires for proper communication. Consult installation manual for your printer.	
		2			
		0			

Table 4-4: Programming Options

Programming Option	Menu Item	Choices	Default	Comments
5824 Expander	Parity	None	X	Select the Parity that your printer requires for proper communication. Consult installation manual for your printer.
		Even		
		Odd		
DST/Clk Options	Clock Source	60 Hz	X	The panel's AC line frequency is selectable for 60, 50 Hz, or Internal. AC Frequency feature dictates how the control panel will calculate time based on the AC line frequency used in the installation site. The "Internal" option can be used in areas where the AC line frequency is not dependable and you want the panel to calculate time from the internal crystal. The internal crystal is not as accurate as the AC power source and either 60 Hz or 50 Hz should normally be selected. The panel defaults to the 60 Hz. selection
		50 Hz		
		Internal		
	Auto DST Adjust	No	X	No automatic clock adjust for Daylight Saving.
		Yes		Automatically changes system clock between Daylight Saving Time (DST) and standard time. Before January 1, 2007, the system clock will switch to DST on the first Sunday in April at 2:00 a.m. and will revert to standard time on the last Sunday in October at 2:00 a.m. On January 1, 2007, the system clock will be adjusted according to the values set in the DST Start (Wk and Mo) and DST End (Wk and Mo) options. Default values for these fields match federal law: DST begins on the second Sunday in March at 2:00 a.m. and reverts to standard time on the first Sunday of November at 2:00 a.m.
	DST Start (Wk)*	1st Sunday		Setting determines the week of the month in which Daylight Saving Time is to start. If you always want the change to occur on the last Sunday of the month, select the Last Sunday option regardless of whether there are four or five Sundays in the month.
		2nd Sunday	X	
		3rd Sunday		
		4th Sunday		
		Last Sunday		
	DST Start (Mo)*	Jan – Dec	Mar	Setting determines the month in which Daylight Saving Time is to end.
	DST End (Wk)*	1st Sunday	X	Setting determines the week of the month in which Daylight Saving Time is to end. If you always want the change to occur on the last Sunday of the month, select the Last Sunday option regardless of whether there are four or five Sundays in the month.
		2nd Sunday		
3rd Sunday				
4th Sunday				
Last Sunday				
DST End (Mo)*	Jan – Dec	Nov	Setting determines the month in which Daylight Saving Time is to start.	

* This option is not recognized by the panel until January 1, 2007. Before January 1, 2007, the panel will recognize the values described above in the Auto DST Adjust option.

Section 5 Operation

To operate the SK-5208 you can use either the on-board touchpad or the Model SK-5235 Remote Annunciator.

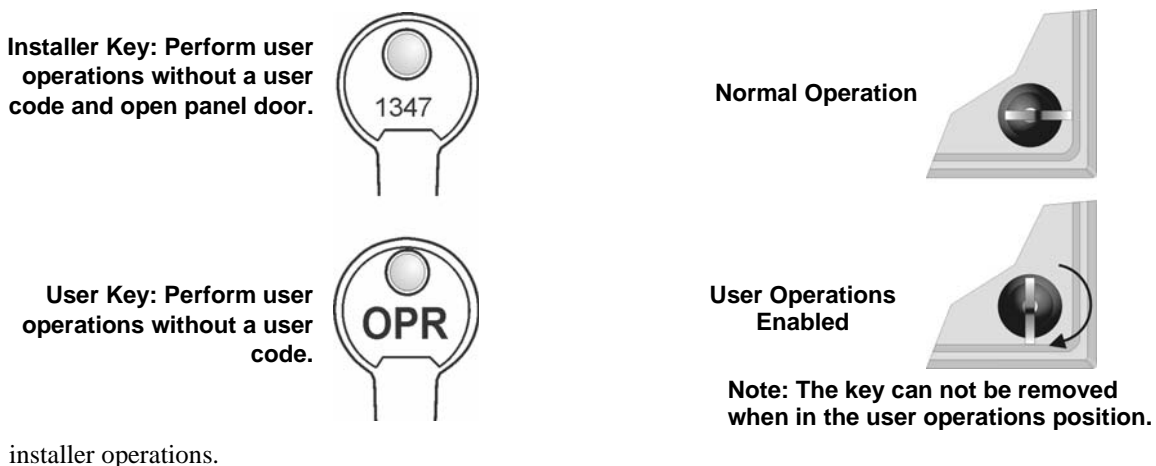

Figure 5-1 Model SK-5235 Remote Annunciator

Important! Upon initial power up there is a 45 second delay before the initiation circuits become active. The system will be ready to receive alarms once the display indicates "System Normal"

5.1 Installer & User Keys

An installer key ships with the panel and an operator's key ships with the SK-5235 (Figure 5-2). The installer key opens the panel door and can be used to perform user operations without a user code at the panel and the SK-5235. The operator's key can be used to perform user operations without a user code but will not open the panel door. All installer operations require an installer code. To perform user operations without a user code, insert and turn the key as shown in Figure 5-2. See Table 5-1 for a list of user and



installer operations.



Figure 5-2 Keys & Key Operation

5.2 On-board Touchpad and SK-5235 Operation

Basic operations for the on-board annunciator (touchpad) and SK-5235 are described in Table 5-1. If you are using an annunciator key or the Flex Door option, you are not required to enter a code for operator level functions.

If no keys are pressed for 4 minutes while in program mode, the system will time out and resume normal operation.

Table 5-1: Basic Panel Operations Using the On-Board Annunciator and the SK-5235

How To	Do This			Comments
	Press	Display Message	Press*	
Test the system	0 ENTER	System Test Enter Code	Enter Code	System performs a display lamp test, a communication test, and displays the firmware number and revision. See 5.2.1 for an example.
Reset Alarms	1 ENTER or RESET	Reset Alarm Enter Code	Enter Code	Resets system.
Clear History	2 ENTER	Clear History Enter Code	Enter Installer Code	Clears event history of all events.
Reset the Dialer	3 ENTER	Reset Dialer Enter Code	Enter Code	Resets the dialer and aborts the call to central station.
Call Computer to Up/Download	4 ENTER	Call Computer Enter Code	Enter Installer Code	Will dial the programmed phone number for the computer to initiate an up or download.
Display History Events	5 ENTER	History Events Enter Code	Enter Code	Displays panel history, including alarms, supervisories, troubles, reports, time and date changes, etc.
Show Status	6 ENTER	Show Status Enter Code	Enter Code	View existing system status. List Alarms first, supervisories and then troubles.
Silence Troubles or Alarms	7 ENTER or SILENCE	Silence Enter Code	Enter Code	
Set the Date	8 ENTER	Set Date Enter Code	Enter Code	Enter 8 digits for the date. For example, to set the date 08/31/1999 enter 08311999. Press # to clear incorrect entries.
Set the Time	9 ENTER	Set Time Enter Code	Enter Code	Enter the time in 24 hour increments. For example, 1:00 pm = 13:00.
Disable/Enable a Zone	Zone # + *	Disable Zone Enter Code	Enter Code	Repeat the process to enable the zone.
Disable/Enable NAC	10 NAC # *	Disable NAC Enter Code	Enter Code	Repeat the process to enable the NAC.
Conduct a Fire Drill	20 ENTER	Fire Drill Enter Code	Enter Code	To End the Fire Drill press RESET then code.
Reset Detectors	21 ENTER	Rst Smk Pwr Enter Code	Enter Code	Resets all smoke detector power.
Walk Test the System	22 ENTER	Walk Test Enter Code	Enter Code	To End the Walk Test press REST.
Menu of Options	Press  or  to scroll through list.			To exit press ENTER or wait 15 seconds.

* Code = any valid operator or installer code.

5.2.1 View Control Panel Firmware Number and Revision

When 0 ENTER and the code is entered The system will perform a display lamp test and a communication test.

Also displays Firmware number and revision as shown in Figure 5-3.

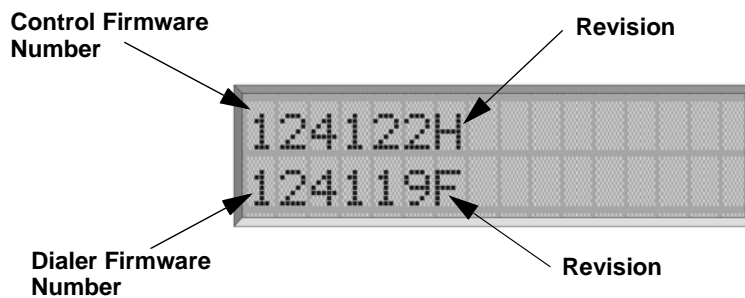

Figure 5-3 Firmware Numbers and Revisions

5.3 Acknowledge Operation

To display an event, first press the ENTER, while the event is displayed the event can be acknowledged by pressing the ENTER button again. No code is required to acknowledge events. The status LEDs (Alarm, Supervisory and Trouble) will flash when an un-acknowledged alarm, supervisory, or trouble condition exists.

After each event has been acknowledged its associated LED (Alarm, Supervisory, or Trouble LED) stop flashing and turn on steady. When viewing system status the LCD displays “Aked” for each individual event once has been acknowledged. The control panel piezo will silence after all alarms have been acknowledged.

Note: The control panel piezo will continue to sound for Supervisories and Troubles even after the event has been acknowledged. Supervisories and troubles will silence once the event is restored.

After the event is acknowledged an event is added to the event history buffer. Acknowledged events in the history buffer will be preceded with an asterisk “*”.

5.4 LED Indicators

Five light emitting diodes (LEDs) appear in the SK-5208 built in annunciator and remote annunciator. The chart below explains the meaning of these LEDs.

Table 5-2

LED	Status	Condition
ALARM (red)	Off	Normal condition
	On	System in alarm and all alarms have been acknowledged.
	Flashing	LED will flash when a alarm condition exists that has not been acknowledged.
SUPERVISORY (yellow)	Off	Normal condition
	On	If a supervisory condition exist on the system.
	Flashing	LED will flash when a supervisory condition exists that has not been acknowledged.
TROUBLE (yellow)	Off	Normal condition
	On	Trouble condition exists
	Flashing	LED will flash when a trouble condition exists that has not been acknowledged.
SILENCED (yellow)	Off	Normal condition.
	On	Alarm or trouble condition has been silenced but condition still exists.
AC (green)	On	Panel is running on AC (normal condition); standby battery fully charged.
	Off	Panel has lost all power.
	Flashing	Panel is running on battery power only or AC power only.

5.5 Releasing Operation

This system can perform two types of releasing operation, cross alarm releasing, and double interlock releasing operations. Install in accordance with NFPA 72 paragraphs 3-8.3.2.3.3 and 3-8.3.2.3.3.2.

5.5.1 Cross Alarm Operation

The fire alarm control panel has two cross alert groups to select from, Cross Alert A and Cross Alert B that accommodate releasing water systems.

When two or more zones are programmed to one of these groups then a single activation of one zone in the group will cause a cross alert condition at the local annunciator and the pre-alert signal output for that group. (**Note:** the local annunciator and the pre-alert signal will continue to sound until it is silenced or until another cross alarm zone within the same group activates.) If a second zone in the same group activates then both will become active alarm zones.

If the second zone is not in the same group as the first zone then the cross alert zone will remain in the cross alert condition and the system will signal the second by how it is programmed.

The fire alarm control panel has four NAC and relay options that allow NACs and relays to be selected to indicate the cross alert condition and assign release circuits for each group.

5.5.1.1 Default NAC Settings for Releasing

When “Cross Alert A” is selected in “Zone Options” the NACs are defaulted to the following settings:

- NAC 1 Releasing Circuit
- NAC 3 Pre-Alert Signal Circuit
- NAC 4 General Alarm Circuit

When “Cross Alert B” is selected in “Zone Options” the NACs are defaulted to the following settings:

- NAC 2 Releasing Circuit
- NAC 3 Pre-Alert Signal Circuit
- NAC 4 General Alarm Circuit

Table 5-3: Cross Alarm Operation

Inputs	Output Results							
	Normal	Pre-Alert	Pre-Alert	Release and General Alarm	Release and General Alarm	Release and General Alarm	Release and General Alarm	Release and General Alarm
Cross Zone 1		X		X		X		X
Cross Zone 2			X	X			X	X
Pull Station					X	X	X	X

A Model 7641 EOL resistor/diode assembly is required when connecting the FACP to releasing solenoids. The 7641 allows the FACP to supervise the wiring between its NACs and the releasing solenoid.

Table 5-4: Approved Releasing Solenoids

Manufacturer	Part Number	Rating
Asco	T8210A107	24 VDC, 16.8 W
	8210G207	24 VDC, 10.6 W

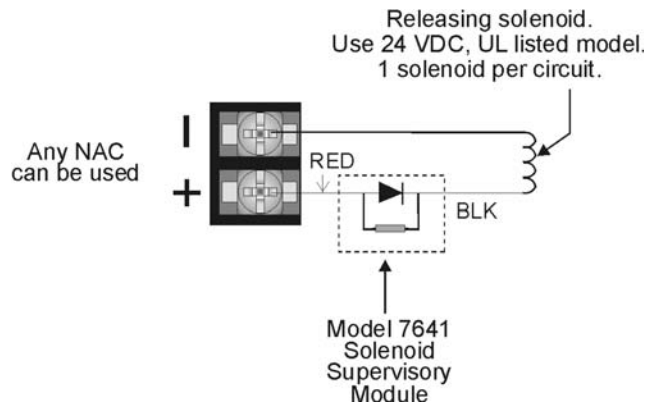
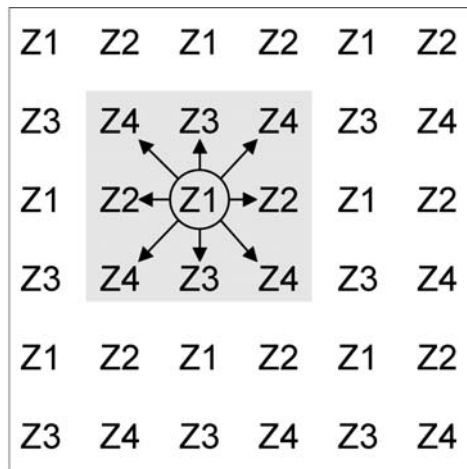

Figure 5-4 Solenoid Wiring Configuration

Do not mix cross alarming zones with smoke verification zones. There must be at least two automatic detection devices in each protected space. Spacing must be reduced to 0.7 times the linear spacing in accordance with NFPA72. See Section 4.2.1 for zone option programming.

Figure 5-5 is an example of how cross alarming may be programmed.



Highlighted segment shows that no Zone 1 detectors are adjacent to any other Zone 1 detector.

Figure 5-5 Example Showing Smoke Detector Cross Alarm Application

5.5.2 Double Interlock Releasing Operation

A typical double interlock releasing system would be programmed with a minimum of two zones selected for “Cross Alert A”, one zone selected as “Man. Release A”, and one selected as “Interlock A”. Additional zones can be selected as Cross Alert or Manual Release.

This double interlock system requires both cross alert and manual release verification zones. A single manual release and interlock zone can be used without any cross alert zones. In this system configuration an active manual release and the interlock zone is required to initiate the release.

Table 5-5 illustrates what will cause a Pre-alert, General Alarm, and a Release.

Table 5-5: Double Interlock Operation

Inputs	Output Results															
Cross Zone 1		X		X		X		X		X		X		X		X
Cross Zone 2			X	X			X	X			X	X			X	X
Manual Release A					X	X	X	X					X	X	X	X
Interlock									X	X	X	X	X	X	X	X
	Normal	Pre-Alert	Pre-Alert	General Alarm	General Alarm	General Alarm	General Alarm	General Alarm	General Alarm	General Alarm	General Alarm	General Alarm	Release and General Alarm	Release and General Alarm	Release and General Alarm	Release and General Alarm

If no zones are selected for “Interlock” verification then the system will operate as a standard cross alarm releasing system (see Section 5.5.1).

See Section 5.5.1.1 for default NAC settings for releasing systems.

5.6 Smoke Alarm Verification

Figure 5-6 illustrates how the Smoke Alarm Verification cycle operates.

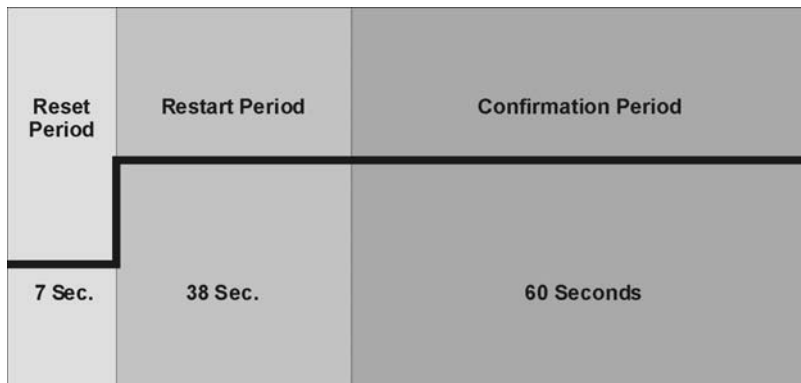

Figure 5-6 Smoke Verification Cycle

During the Confirmation Period if there is no alarm indication then the system will return to normal operation.

5.7 System Testing

This section describes operation of fire drills, zone testing, and the 24-hour automatic test.

5.7.1 Fire Drills

Fire drills can be run from either the on-board touchpad or the Model SK-5235 Remote Annunciator. To initiate a fire drill, press 20 ENTER + Code. The system will sound an alarm and report a fire test. To end the fire drill, press RESET + Code.

5.7.2 Walk Test

The walk test is designed to be used for on-site testing only.

To enter walk test mode, press 22 ENTER + Installer Code.

Select the following test parameters:

Test Feature	Enable or Disable	Comments
Use Verify:	Yes or No	If Yes is selected then this option will be enabled during walk test. If No is selected this option will be disabled during walk test.
Mapped Rlys:	Yes or No	
Mapped NACs:	Yes or No	

The LCD will indicate that you are in walk test mode. When a zone is tripped, the SK-5208 will activate the bell outputs for approximately six second and will cycle smoke power off and on for the programmed time interval. When smoke power is restored, there is a two-second power up delay before the zone will respond to additional test inputs.

The system will time out and resume normal operation in 30 minutes if no keys are pressed or no zones are tripped during the walk test.

To exit walk test mode, press RESET.

5.7.3 Automatic Self Test

The Model SK-5208 lets you select the time of day and the interval that the automatic that the test signal will be sent to the central station. See Sections 4.2.10 and 4.3 for additional information on automatic test time.

5.7.4 Watchdog Circuit

During normal operation, the control microprocessor of the SK-5208 is constantly running programs to check inputs and carry out other routine functions. If the program should ever stop running, the watchdog circuit will automatically detect this and attempt to resume normal operation by resetting the microprocessors. Each time the watchdog circuit initiates a reset signal, it will also sound the audible trouble signal for approximately four seconds.

5.8 Communicating with a Programming Computer

An installer at the panel site can initiate communications between the panel and a computer running the Silent Knight Software Suite SKSS. In order for this communication to function properly both the computer (running the software) and the control panel must have matching computer account numbers and computer access codes.

Before you program in this location you should know how your control panel will communicate with the downloading computer, either through direct connect (RS232) or via the phone lines (Internal Modem).

5.8.1 Programming From a Remote Computer Location

The panel can communicate with a Up/Downloading computer using two methods. The control panel can call the programming computer or the programming computer can call the control panel.

The programming information for the control panel will be stored in the queue of the downloading software SKSS P/N 5660. This data packet will have been pre-configured for the control panel that you are about to program. SKSS is available to download on www.silentknight.com. For more information also see *SKSS Installation Manual P/N 151240*.

5.8.1.1 Having the Control Panel Call the Remote Computer

If the panel initiates the call to a downloading computer, a phone number must be programmed in the computer accounts area (see Section 4.2.8).

To initiate communication:

1. From the SKSS Up/Downloading software File Menu, select the download or upload menu item you want to perform.
2. In the appropriate locations in the dialog box, enter your information.
3. When ready, select “Wait for Call” in the “Call how often” drop down list.
4. Press “OK” to stage SKSS for an Up/Download.
5. Press the 4 ENTER or the ^ up arrow until the display reads Call Computer.
6. Enter the Installer Code.

The control panel will then begin the communication process with the remote computer.

5.8.1.2 Having Remote Computer Call the Control Panel

If the computer initiates the call then answering machine bypass (see Section 4.2.8) may need to be selected.

To initiate communication:

1. From the SKSS Up/Downloading software File Menu, select the download or upload menu item you want to schedule.

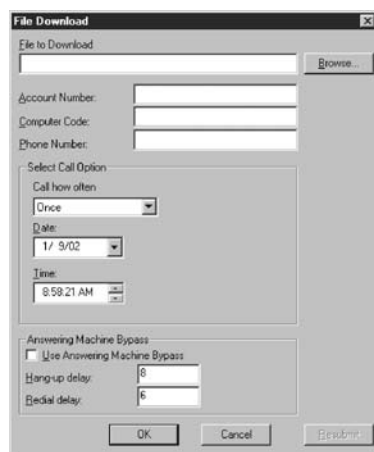

Download Menu



Upload Menu

2. In the appropriate locations in the dialog box, enter your selections for the following options:

File Name: To download, select the file that you want to download. To upload assign a name to the file that will be uploaded from the panel. You can use the Browse option to select from the list of available files. If

you do not select a name for the file, it will be automatically named with the panel model and the date and time of the download.

For downloads, the latest saved version of the file will be sent. This means if the file you want to send is currently open and has been changed, save it before you attempt to download.

Account

Number: Enter the panel account number.

Computer Code: Enter the code that allows access to the panel from a PC.

Phone Number: Enter the panel phone number.

Call Option: Select how often and when the call should be placed.

Answering: Select the preferred options if the phone line used by the control panel has an answering machine installed. This feature is not used when connecting directly to a panel.

3. Click **OK** to begin downloading/uploading or to post the job to the Queue.

5.8.2 Directly Connecting to a Programming Computer

The control panel can be up or downloaded from a computer that is directly connected to the control panel.

Note: This connection is to be used as a temporary connection and should be disconnected after programming is completed.

To initiate communication:

1. Connect a serial cable from the control panel to the computer.

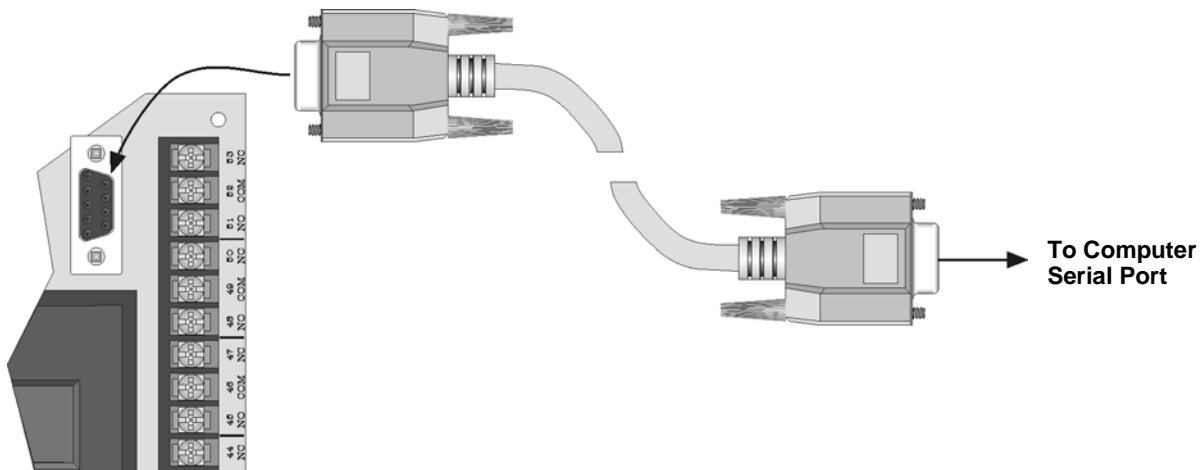

2. Make sure SKSS software is running and that the up/download task is in the queue, by selecting the Call Option to "Wait for Call".
3. Initiate an up/download from SKSS

The control panel will then begin the communication process with the computer.

Section 6

Reporting

The SK-5208 can transmit information in four different formats. This section describes the four basic reporting formats of the SK-5208 and the codes that they send to a central station receiver. Of these four formats some of the formats offer a more specific selection for that format. For example, you can select a 3/1 format that requires a 1400 or 2300 Hz handshake, or SIA format that can handle 8 or 20 events per call. Selecting the correct format depends on the type of receiver that will receive calls from the SK-5208.

The SK-5208 DACT is compatible with Silent Knight Model 9800 and 9500 Digital Receivers.

6.1 Reporting Formats

This section gives a description of each of the SK-5208 reporting formats. Refer to Table 6-1.

Table 6-1: Reporting Formats Descriptions

Format Name		Description
Category Name	Programming Name	
3/1	3/1 14	Old format, transmits a 3-digit account number and a 1-digit event code. Transmissions are acknowledged at 1400 Hz.
	3/1 23	Old format, transmits a 3-digit account number and a 1-digit event code. Transmissions are acknowledged at 2300 Hz.
4/2	SK4/2 1400	Tone burst format, transmits a 4-digit account code and 2-digit event code. Transmissions are acknowledged at 1400 Hz.
SIA	SIA8	Security Industry Association standard communication format which send a maximum of 8 events per call.
	SIA20	Security Industry Association standard communication format which send a maximum of 20 events per call. Up to a 6-digit account number.
Contact ID	Contact ID	Ademco Contact ID format. DTMF (Dual Tone Multiple Frequency) format. Send a 4-digit account number. Transmission is acknowledged at both 1400 and 2300 Hz.

6.2 Reporting Codes

Table 6-2 list the events sent by the SK-5208 and the code that is sent for that event by the type of reporting format used.

Note: Codes under in the SK4/2 and 3/1 1400 & 2300 column are the codes programmed for 3/1 reporting formats in Misc Reporting. See Section 4.2.10 for Misc. Reporting options and Table 6-3 for default 3/1 format reporting values.

Table 6-2: Event and Reporting Code by Format

Event	SIA8 & 20	SK4/2	3/1 1400 & 2300	Contact ID
AC Trouble	AT0	T0	Trouble Code	1 301 000
AC Restore	AR0	R0	Restore Code	3 301 000
Annunciator Trouble 1-7	ET17 - ET23	T7 - T3	Trouble Code	1 330 017 - 1 330 023
Annunciator Restore 1-7	ER17 - ER23	R7 - R3	Restore Code	3 330 017 - 3 330 023
Bell Trouble 1-4	ET32-ET35	T2 - T5	Trouble Code	1 330 032 - 1 330 035
Bell Restore 1-4	ER32-ET35	R2 - R5	Restore Code	3 330 032 - 3 330 035
Smoke (Loop) Power Trouble	ET36	T6	Trouble Code	1 320 036
Smoke (Loop) Power Restore	ET36	R6	Restore Code	3 320 036
Aux Power Trouble	ET37	T7	Trouble Code	1 330 037
Aux Power Restore	ER37	R7	Restore Code	3 330 037
Earth Ground Trouble	ET38	T8	Trouble Code	1 330 038
Earth Ground Restore	ER38	R8	Restore Code	3 330 038
Keypad Power Trouble	ET40	T0	Trouble Code	1 330 040
Keypad Power Restore	ET40	R0	Restore Code	3 330 040
5217 Expander Trouble	ET51-ET52	T1 - T2	Trouble Code	1 330 051 - 1 330 052
5217 Expander Restore	ER51-ER52	R1 - R2	Restore Code	3 330 051 - 3 330 052
5280 Expander Trouble	ET61-ET68	T1 - T8	Trouble Code	1-330 061 - 1 330 068
5280 Expander Restore	ER61-ER68	R1 - R8	Restore Code	3-330 061 - 3 330 068
NAC Bypass	ET101-ET104	T1 - T4	Trouble Code	1-330 101 - 1 330 104
NAC Restore	ER101-ER104	R1 - R4	Restore Code	3-330 101 - 3 330 104
NAC Supervisory (See Note)	SS101-SS104	S1 - S4	Supervisory Code	1 203 101 - 1 203 104
NAC Supervisory Restore (See Note)	SR101-SR104	R1 - R4	Restore Code	3 203 101 - 3 203 104
Fire Alarm 1-30	FA1 - FA30	A1 - A0	Alarm Code	1 110 001 - 1 110 030
Fire Bypass	FB1-FB30	T1 - T0	Trouble Code	1 571 001 - 1 571 030
Fire Alarm Restore 1-30	FH1 - FH30	AR1 - AR0	Alarm Restore Code	3 110 001 - 3 110 030
Fire Test Begin	FI1 - FI10	Test 0	Test Code	1 604 000
Fire Trouble Restore 1-30	FJ1 - FJ30	R1 - R0	Restore Code	3 373 001 - 3 373 030
Fire Test End	FK0	Test 0	Test Code	1 604 000
Fire Restore/Clean-Me Restore	FR1-FR30	R1 - R0	Restore Code	3 110 001 - 3 110 030

Note: These reports are sent for Notification Appliance Circuits that are programmed for releasing operation.

Table 6-2: Event and Reporting Code by Format

Event	SIA8 & 20	SK4/2	3/1 1400 &2300	Contact ID
Fire Trouble/Clean-Me Trouble 1-30	FT1 - FT30	T1 - T0	Trouble Code	1 373 001 - 1 373 030
Fire Unbypass	FU1-FU30	R1 - R9	Restore Code	3 571 011 - 3 571 030
Heat Alarm	KA1-KA30	A1 - A9	Alarm Code	1 114 001 - 1 114 030
Heat Bypass	KB1-KB30	T1 - T0	Trouble Code	1 570 011 - 1 570 030
Heat Alarm Restore	KH1-KH30	AR1 - AR0	Alarm Restore Code	3 114 001 - 3 114 030
Heat Trouble	KT1-KT30	T1 - T0	Trouble Code	1 370 001 - 1 370 030
Heat Trouble Restore	KJ1-KJ30	R1 - R0	Restore Code	3 370 001 - 3 370 030
Heat Restoral	KR1-KR30	R1 - R0	Restore Code	3 370 001 - 3 370 030
Heat Unbypass	KU1-KU30	R1 - R0	Restore Code	3 570 001 - 3 570 030
Trouble Phone Line #1	LT1	T1	Trouble Code	1 351 000 01
Restore Phone Line #1	LR1	R1	Restore Code	3 351 000 01
Trouble Phone Line #2	LT2	T2	Trouble Code	1 352 000 02
Restore Phone Line #2	LR2	R2	Restore Code	3 352 000 02
Automatic Test (Normal)	RP0	Test 0	Test Code	1 602 000
Automatic Test (Abnormal)	RY0	Test 9	Test Code	1 608 000
Power Up	RR0	T0	Test Code	1 305 000
Downloading Passed	RS0	Test 0	Test Code	1 412 000
Data Lost	RT0	Test 0	Trouble Code	1 354 000
Downloading Failed	RU0	Test 0	Test Code	1 413 000
Manual Test	RX1-RX10	Test 1 - Test 0	Test Code	1 601 001 - 1 601 010
Sprinkler Alarm	SA1-SA30	A1 - A0	Alarm code	1 113 001 - 1 113 030
Sprinkler Bypass	SB1-SB30	T1 - T0	Trouble Code	1 570 001 - 1 570 030
Sprinkler Alarm Restore	SH1-SH30	AR1 - AR0	Alarm Restore Code	3 113 001 - 3 113 030
Sprinkler Trouble Restore 1-30	SJ1 - SJ30	R1 - R0	Restore Code	3 370 001 - 3 370 030
Sprinkler Supervisory Restore 1-30	SR1 - SR30	R1 - R0	Restore Code	3 203 001 - 3 203 030
Sprinkler Supervisory 1-30	SS1 - SS30	S1 - S0	Supervisory Code	1 203 001 - 1 203 030
Sprinkler Trouble 1-30	ST1 - ST30	T1 - T0	Trouble Code	1 370 001 - 1 370 030
Sprinkler Unbypass 1-30	SU1-SU30	R1 - R0	Restore Code	3 570 001 - 3 570 030
Untyped Zone Alarm 1-30	UA1-UA30	A1 - A0	Alarm Code	1 140 001 - 1 140 030
Untyped Bypass 1-30	UB1-UB30	T1 - T0	Trouble Code	1 570 001 - 1 570 030
Untyped Alarm Restore 1-30	UH1-UH30	AR1 - AR9	Alarm Restore Code	3 140 001 - 3 140 030
Untyped Trouble Restore 1-30	UJ1-UJ30	R1 - R0	Restore Code	3 370 001 - 3 370 030
Untyped Zone Trouble 1-30	UT1-UT30	T1 - T0	Trouble Code	1 370 001 - 1 370 030
Untyped Zone Unbypass 1-30	UU1-UU30	R1 - R0	Restore Code	3 570 001 - 3 570 030
Water Alarm 1-30	WA1-WA30	A1 - A0	Alarm Code	1 154 001 - 1 154 030

Table 6-2: Event and Reporting Code by Format

Event	SIA8 & 20	SK4/2	3/1 1400 &2300	Contact ID
Water Bypass 1-30	WB1-WB30	T1 - T0	Trouble Code	1 570 001 - 1 570 030
Water Alarm Restore 1-30	WH1-WH30	AR1 - AR0	Alarm Restore Code	3 154 001 - 3 154 030
Water Trouble Restore 1-30	WJ1-WJ30	R1 - R0	Restore Code	3 370 001 - 3 370 030
Water Trouble 1-30	WT1-WT30	T1 - T0	Trouble Code	1 370 001 - 1 370 030
Water Unbypass 1-30	WU1-WU30	R1 - R0	Restore Code	3 570 001 - 3 570 030
Communications Failure Line #1	YC1	T1	Trouble Code	1 354 001
Communications Restore Line #1	YK1	R1	Restore Code	3 354 001
Communications Failure Line #2	YC2	T2	Trouble Code	1 354 002
Communications Restore Line #2	YK2	R2	Restore Code	3 354 002
System Battery Restore	YR0	R0	Restore Code	3 302 000
System Battery Trouble	YT0	T0	Trouble Code	1 302 000
Cold Alarm 1-30	ZA1-ZA30	A1 - A0	Alarm Code	1 153 001 - 1 153 030
Cold Bypass 1-30	ZB1-ZB30	T1 - T0	Trouble Code	1 570 001 - 1 570 030
Cold Alarm Restore 1-30	ZH1-ZH30	AR1 - AR0	Alarm Restore Code	3 153 001 - 3 153 030
Cold Trouble Restore 1-30	ZJ1-ZJ30	R1 - R0	Restore Code	2 370 001 - 3 370 030
Cold Trouble 1-30	ZT1-ZT30	T1 - T0	Trouble Code	1 370 001 - 1 370 030
Cold Unbypass 1-30	ZU1-ZU30	R1 - R0	Restore Code	3 570 001 - 3 570 030

6.2.1 Default Settings for 3/1 Format

Table 6-3 displays the default settings which are set in the Misc. Reporting section of Programming.

Table 6-3: Default Settings for 3/1 Format

Programming Option	Menu Item	Choices	Default	Comments
Misc Reporting	Test Time	00:00 - 23:59	12:00	Selects the time of day the control will send an automatic test signal to a central station receiver.
	Test Interval	Every 4		Selects the period to which the system performs an Automatic Self Test, keyed off the Test Time.
		Every 6		
		Every 12		
		Every 24	X	
	AC Delay	0-30 Hours	2	Selects the delay time (in hours) before the control will report an AC power loss to the central station.
	Report Walk Test	No	X	No zone information will be reported just test begin and test end.
		By Zone		Test begin, test end, and all events in between will be reported to central station.
	*3/1 Alarm	0 - 9 * Event code for 3/1 and 4/2 reporting formats.	0	Alarms for Fire, Waterflow, Undefined, Heat, Cold, and Water events.
	*3/1 Alarm Rst		2	Alarms restores for Fire, Waterflow, Undefined, Heat, Cold, and Water events.
	*3/1 Supervisory		6	Sprinkler supervisories.
*3/1 Restore	7		Restore reports for Troubles, Supervisories, and unbypasses. The only exceptions are the restores listed as alarm restores.	
*3/1 Trouble	8		All system and zone troubles, and zone/NAC bypasses, and NACs troubles.	
*3/1 Test	9		All test events.	

Section 7

Troubleshooting

This section of the manual contains information that can be used to isolate and correct installation problems encountered in the field.

7.1 System Error Messages

Table 7-1 contains a list of possible error messages along with their meaning and possible solution.

Table 7-1: Error Messages

Error Message	Description	Solution
FLASH Defaulted	On power up the SK-5208 will check the flash for an "option record".	If an "option record" is not found during power up, one will be created and the display will indicate "Flash Defaulted" for approximately one second.
Earth Fault Trb	The SK-5208 has built-in earth ground fault detection that will detect an earth ground fault connection between earth and any panel terminal. When an earth ground fault is detected the SK-5208 display will indicate Earth Fault Trb. The SK-5208 will also add two events to the history buffer Expand Trb 38 and Earth ###. The Earth ### is a debug event number between 0 and 255.	See Section 7.2 for earth ground fault troubleshooting procedure.
Key BUS Trouble	This message will display when communication is lost between the 5235 and the control panel.	Check for a short or an open on either the SKI or SKO terminals.
NAC # Trb	This message indicates that a short or an open is detected on a Notification Appliance Circuit. The # indicates which NAC has the trouble.	Check for a short or an open on the indicated NAC wire run.
Remote # Trb	Each 5235 can be programmed to be supervised (see Section 4.2.2). If the SK-5208 is unable to communicate with the 5235 it will indicate this message. # indicates the ID number of the faulted touchpad.	Check the wire connections between the indicated touchpad and the control panel.
5217 Trb #	If the SK-5208 is unable to communicate with a 5217 expander it will display this message. The # indicates the ID number of the expander in trouble.	Check all wire connections between the control panel and the 5217 expander in trouble.
5280 Trb #	If the control panel is unable to communicate with a SK-5280 Status Display Module this message will be displayed. # indicates the ID number of the SK-5280 in trouble.	Check all wire connections between the control panel and the SK-5280 in trouble.
Smk Pwr Trb	Smoke power terminals 11, 14, 17, and 20 are supervised. If the voltage between circuit ground (terminals 9, 22, 26, 33) and loop power is less than 20VDC this message will display.	This may occur when the maximum current draw for the initiation circuit is exceeded. See Section 3.11 for initiation circuit current requirements.
5235 Pwr Trb	The power terminal for the 5235 is supervised and a trouble indication will occur if the voltage between circuit ground and terminal 32 drops below 20 VDC.	This may occur if the maximum current rating (1Amp) for this circuit is exceeded.

Table 7-1: Error Messages

Error Message	Description	Solution
Aux Pwr Trb	The SBUS power terminal (27) is supervised and will display this message when the voltage between SBUS power and circuit ground drops below 20 VDC.	This may occur if the maximum current rating (1Amp) for this circuit is exceeded.
AC Trb	This message is displayed when the AC voltage drops below 98 VAC.	Check the AC power connection. This report will be sent to the central station after the AC delay time has expired. See Section 4.2.10 to program AC delay time.
Battery Trb	This message will be displayed when the battery voltage drops below 20.4 VDC under load. The control panel performs a load test every minute.	Check battery connection. Verify that the control panel has AC power.
Ph Line # Trb	This message is displayed when the phone line voltage drops below 2 VDC or can not supply a minimum of 4 mA of current. The # indicates which phone line is in trouble.	
Data Lost	This event will be reported to the central station if the reporting buffer fills. This may occur if more that 24 events need to be reported. When the report buffer is full and additional events are added to the report buffer, the oldest event will be overwritten and the data lost event will be added.	
Com # Trb	The SK-5208 must use alternating phone lines (according to NFPA) when reporting auto tests and manual tests. If the control panel can not communicate using the selected phone line, the Com # Trb message will be displayed. The # indicates which line had the trouble.	The trouble condition will clear after the control panel is successful in communicating using the phone line.

7.2 Earth Ground Fault Troubleshooting

An Earth Fault Trb indicates that the panel has detected a short between any terminal on the panel and earth ground. To determine the location of the short, place a DC volt meter with ground on terminal 22 (circuit ground) and positive on any of the screws that secure the circuit board to the cabinet (earth ground).

A typical meter reading should alternate between 0 VDC and 11.7 VDC. Any other voltage will put the panel into Earth Fault Trb (see also Table 7-1). Remove and leave off field wiring from the panel until the meter alternates between 0 VDC and 11.7 VDC.

When an Earth Fault is indicated at the touchpad two messages will be added to the event history buffer, Earth Fault 38 and Earth ###. This information can be very helpful to identify where an earth ground fault exists in an intermittent earth ground situation.

If the Earth ### is lower than 133 this typically would indicate an earth ground short to a low voltage source (13.1 VDC or less). For example, any circuit ground terminal or zone input terminal.

If the Earth ### is higher than 134 this typically would indicate an earth ground to a higher voltage source (13.1 VDC or higher). For example, any circuit power, standby battery, phone lines, or AC power.

7.3 Earth Fault Resistance

Table 7-2 list the earth fault resistance values for each applicable terminal on the FACP.

Table 7-2: Earth Fault Resistance Values by Terminal

Function	Terminal Number	Terminal Label	Earth Fault Resistance Value (in Ohms)	
Zone 1 input.	1	A	Z1	0K
	2	B		0K
	3	C		0K
	4	D		0K
Zone 2 input	5	A	Z2	0K
	6	B		0K
	7	C		0K
	8	D		0K
Ground	9	GND		0K
Zone 3 input	10	Z3		0K
Power (Zone 3 & 4)	11	PWR		0K
Zone 4 input	12	Z4		0K
Zone 5 input	13	Z5		0K
Smoke Power	14	PWR		0K
Zone 6 input	15	Z6		0K
Zone 7 input	16	Z7		0K
Smoke Power	17	PWR		0K
Zone 8 input	18	Z8		0K
Zone9 input	19	Z9		0K
Smoke Power	20	PWR		0K
Zone 10 input	21	Z10		0K
Ground	22	GND		0K
AC Power Connections	23	B		NA
	24	Earth		NA
	25	W		NA
SBUS Connections	26	GND		0K
	27	+24DC		0K
	28	A		0K
	29	B		0K
Remote Annunciator Connections	30	SKI		0K
	31	SKO		0K
	32	PWR		0K
	33	GND		0K
Notification Appliance Circuit 4	34	+	NAC4	0K
	35	-		0K
Notification Appliance Circuit 3	36	+	NAC3	0K
	37	-		0K
Notification Appliance Circuit 2	38	+	NAC2	0K
	39	-		0K
Notification Appliance Circuit 1	40	+	NAC1	0K
	41	-		0K

Appendix A

Compatible Devices

This section of the manual lists devices (smoke detectors and notification appliances) that are compatible with the SK-5208. Contact Silent Knight if you have a question about whether a device not listed here is compatible.

A.1 Notification Appliances

For proper operation, you must use polarized devices with a Model 7628 4.7k ohm EOL resistor on each loop. All supervised notification appliances used with the control panel must be polarized. The table below lists notification appliances compatible with the FACP. Appliances which can be synchronized indicate the type of sync available in the columns marked Audio and/or Visual.

Note: Not all devices can use the Sync feature, be sure to check table below to ensure the device you have chosen will work with this feature. Synchronization is UL listed as a single circuit operation.

Table A-1: Compatible Notification Appliances

Manufacturer	Model	Audio	Visual	Type
AMSECO	SH24W-153075	x	x	Horn/Strobe
	SAD24-153075		x	Strobe
	SAD24-75110		x	Strobe
	SL24W-75110		x	Strobe
	SL24C-3075110		x	Strobe
	SLB24-75		x	Strobe
	RSD24-153075		x	Strobe
	RSD24-75110		x	Strobe
	SH24W-75110	x	x	Horn/Strobe
	SH24W-3075110	x	x	Horn/Strobe
	SHB24-75	x	x	Horn/Strobe
	SCM24W-153075	x		Chimes/Strobe
	SCM24W-75110	x		Chimes/Strobe
	SCM24C-3075110	x		Chimes/Strobe
	SCM24C-177	x		Chimes/Strobe
	H24W	x		Horn
	H24R	x		Horn

Table A-1: Compatible Notification Appliances

Manufacturer	Model	Audio	Visual	Type
Faraday	446	x		Vibrating Bell
	476	x		Vibrating Bell
	477	x		Single Stroke Bell
	2700 -M, -R, -T, -Y, -Z		x	Strobe
	2701 Series		x	Strobe
	2705 Series		x	Strobe
	2820	x	x	Sync Temporal Horn/Strobe
	2821	x	x	Sync Temporal Horn/Strobe
	2824	x	x	Horn Strobe
	5333	x		Multi-Tone Horn)
	5336	x	x	Multi-Tone Horn/Strobe
	5337	x	x	Multi-Tone Horn/Strobe
	5338	x	x	Multi-Tone Horn/Strobe
	5343	x	x	Single Tone Horn/Strobe
	5346	x	x	Electronic Horn with Strobe
	5347	x	x	Electronic Horn with Strobe
	5348	x	x	Single Tone Horn/Strobe
	5373	x	x	8-Tone Horn/Strobe
	6321	x	x	Sync Mini Horn/Strobe
	6322	x	x	Mini Horn/Sync Strobe
6380		x	8-Tone Electronic Signal/Strobe	
5376	x	x	8-Tone Horn/Strobe	
5377	x	x	8-Tone Horn/Strobe	

Table A-1: Compatible Notification Appliances

Manufacturer	Model	Audio	Visual	Type
Faraday (cont.)	5378	x	x	8-Tone Horn/Strobe
	5383	x	x	8-Tone Horn/Strobe with Sync Strobe
	5386	x	x	8-Tone Horn/Strobe with Sync Strobe
	5387		x	8-Tone Horn/Strobe with Sync Strobe
	5388		x	8-Tone Horn/Strobe with Sync Strobe
	5508		x	Single Gang Sync Strobe
	5509		x	Strobe
	5510		x	Strobe
	5511		x	Strobe
	5512		x	Strobe
	5516		x	Strobe
	5517		x	Strobe
	5518		x	Strobe
	5519		x	Strobe
	5521		x	4" Square Sync Strobe
	5522		x	4" Square Sync Strobe
	6120	x		Horn
	6140	x		Horn
	6223	x		Horn
	6226	x	x	Horn/Strobe
	6227	x	x	Horn/Strobe
	6228	x	x	Horn/Strobe
	6243	x		Electron-Mechanical Horn
	6244	x		Electron-Mechanical Horn
	6245	x		Electron-Mechanical Horn
	6246	x	x	Electron-Mechanical Horn/Strobe
	6247	x	x	Electron-Mechanical Horn/Strobe
	6248	x	x	Electron-Mechanical Horn/Strobe
	6300	x		Mini-Horn
	6301	x		Mini-Horn
	6302	x		Mini-Horn
	6310	x	x	Mini-Horn/Strobe
	6311	x	x	Mini-Horn/Strobe
	6312	x	x	Mini-Horn/Strobe
6314 Series -M, -R, -T, -Y, -Z		x	Strobe	
6320	x	x	Sync Mini Horn/Strobe	

Table A-1: Compatible Notification Appliances

Manufacturer	Model	Audio	Visual	Type	
FCI	S2415-FC		x	Strobe	
	S241575-FC		x	Strobe	
	S2430-FC		x	Strobe	
	130-3117C	x		Mini Horn	
	130-3147C	x		Mini Horn	
	BLV-6	x		Vibrating Bell	
	BLV-10	x		Vibrating Bell	
FCI (cont.)	BLVCH	x		Vibrating Chime	
	H12/24-FC	x		Horn	
	H12/24W-FC	x		Horn	
	H12/24K-FC	x		Horn	
	HC12/24-FC	x		Horn	
	HC12/24W-FC	x		Horn	
	HC12/24K-FC	x		Horn	
	P2415-FC	x	x	Horn/Strobe	
	P2415W-FC	x	x	Horn/Strobe	
	P2415K-FC	x	x	Horn/Strobe	
	P241575-FC	x	x	Horn/Strobe	
	P241575W-FC	x	x	Horn/Strobe	
	P241575F-FC	x	x	Horn/Strobe	
	P241575K-FC	x	x	Horn/Strobe	
	P2430-FC	x	x	Horn/Strobe	
	P2430W-FC	x	x	Horn/Strobe	
	P2430K-FC	x	x	Horn/Strobe	
	P2475-FC	x	x	Horn/Strobe	
	P2475W-FC	x	x	Horn/Strobe	
	P2475K-FC	x	x	Horn/Strobe	
	P24110-FC	x	x	Horn/Strobe	
	P24110W-FC	x	x	Horn/Strobe	
	P24110K-FC	x	x	Horn/Strobe	
	S2430W-FC		x	Strobe	
	S2430K-FC		x	Strobe	
	S2475-FC		x	Strobe	
	S2475W-FC		x	Strobe	
	S2475K-FC		x	Strobe	
	S24110-FC		x	Strobe	
	S24110W-FC		x	Strobe	
	S24110K-FC		x	Strobe	
	Federal Signal	450	x		Horn
		VALS	x	x	Horn/Strobe

Table A-1: Compatible Notification Appliances

Manufacturer	Model	Audio	Visual	Type
Gentex	GEC-24-15	x	x	Horn/Strobe
	GEC-24-30	x	x	Horn/Strobe
	GEC-24-60	x	x	Horn/Strobe
	GEC-24-75	x	x	Horn/Strobe
	GEC-24-177	x	x	Horn/Strobe
	GEC-24-110	x	x	Horn/Strobe
	GEC-24-15/75	x	x	Horn/Strobe
	GX91	x		MiniHorn Steady Tone
	GX93	x		MiniHorn Temporal Tone
Gentex (cont.)	HG124	x		Horn
	HS24-15	x	x	Horn/Strobe
	HS24-30	x	x	Horn/Strobe
	HS24-60	x	x	Horn/Strobe
	HS24-75	x	x	Horn/Strobe
	HS24-110	x	x	Horn/Strobe
	HS24-1575	x	x	Horn/Strobe
	GCC24	x	x	Multi Candella Horn/Strobe Ceiling Mount
	GCCR24		x	Multi Candella Horn/Strobe Ceiling Mount
	GCS24		x	Multi Candella Strobe Ceiling Mount
	GCSR24		x	Multi Candella Strobe Ceiling Mount
	GEGR-24	x	x	Multi Candella Horn/Strobe
	GES24-15		x	Strobe
	GES24-30		x	Strobe
	GES24-60		x	Strobe
	GES24-75		x	Strobe
	GES24-110		x	Strobe
	GES24-15/75		x	Strobe
	GES24-177		x	Strobe
	GES3-24		x	Multi Candella Strobe
	GESR-24		x	Multi Candella Strobe
	GEH-24	x		Horn
	ST24-30		x	Strobe
	ST24-60		x	Strobe
	ST24-75		x	Strobe
	ST24-110		x	Strobe
	ST24-1575		x	Strobe
	WGEC24-75W	x	x	Weatherproof Horn/Strobe
	WGES24-75W		x	Weatherproof Strobe
	WGMS-24-X	x	x	Horn/Strobe

Table A-1: Compatible Notification Appliances

Manufacturer	Model	Audio	Visual	Type
System Sensor	CHR	x		Chime
	CHW	x		Chime
	CHSR	x	x	2-Wire Chime/Strobe
	CHSW	x	x	2-Wire Chime/Strobe
	HR	x	x	Horn
	HW		x	Horn
	HRK		x	Horn
	HWL		x	Horn WHT Wall 4x4
	HRL		x	Horn Red Wall 4x4
	HGRL		x	Horn Red Wall 2x4
	HGWL		x	Horn WHT Wall 2x4
	CHWL	x		Chime WHT Wall 4x4
	CHRL	x		Chime Red Wall 4x4
	CHSRL	x	x	Chime/Strobe Red Wall 4x4
	CHSWL	x	x	Chime/Strobe WHT Wall 4x4
	CHSCRL	x	x	Chime/Strobe Red Ceil 4x4
	CHSCWL	x	x	Chime/Strobe WHT Ceil 4x4
	P2R	x	x	2-Wire Horn/Strobe
	P2R-P	x	x	2-Wire Horn/Strobe
	PC2R	x	x	2-Wire Horn/Strobe
	PC2R-P	x	x	2-Wire Horn/Strobe
	P2RH	x	x	2-Wire Horn/Strobe High Candela
	P2RH-P	x	x	2-Wire Horn/Strobe High Candela
	PC2RH	x	x	2-Wire Horn/Strobe High Candela
	PC2RH-P	x	x	2-Wire Horn/Strobe High Candela
	P2W	x	x	2-Wire Horn/Strobe
	P2W-P	x	x	2-Wire Horn/Strobe
	PC2W	x	x	2-Wire Horn/Strobe
	PC2W-P	x	x	2-Wire Horn/Strobe
	P2WH	x	x	2-Wire Horn/Strobe High Candela
	P2WH-P	x	x	2-Wire Horn/Strobe High Candela
	PC2WH	x	x	2-Wire Horn/Strobe High Candela
	PC2WH-P	x	x	2-Wire Horn/Strobe High Candela
	P2RK	x	x	2-Wire Horn/Strobe
	PC2RK	x	x	2-Wire Horn/Strobe
	P2RHK	x	x	2-Wire Horn/Strobe High Candela
	PC2RHK	x	x	2-Wire Horn/Strobe High Candela
	P4R	x	x	4-Wire Horn/Strobe
	PC4R	x	x	4-Wire Horn/Strobe
	P4RH	x	x	4-Wire Horn/Strobe High Candela

Table A-1: Compatible Notification Appliances

Manufacturer	Model	Audio	Visual	Type
System Sensor (cont.)	P4W	x	x	4-Wire Horn/Strobe
	PC4W	x	x	4-Wire Horn/Strobe
	P4WH	x	x	4-Wire Horn/Strobe High Candela
	PC4WH	x	x	4-Wire Horn/Strobe High Candela
	P4RK	x	x	4-Wire Horn/Strobe
	PC4RK	x	x	4-Wire Horn/Strobe
	P4RHK	x	x	4-Wire Horn/Strobe High Candela
	PC4RHK	x	x	4-Wire Horn/Strobe High Candela
	PC4RH	x	x	4-Wire Horn/Strobe High Candela
	P2RL, P2RL-P, P2RL-SP*	x	x	Horn/Strobe 2W Red Wall 4x4
	P2WL, P2WL-P, P2WL-SP*	x	x	Horn/Strobe 2W WHT Wall 4x4
	PC2RL	x	x	Horn/Strobe 2W Red Ceil 4x4
	PC2WL	x	x	Horn/Strobe 2W WHT Ceil 4x4
	P2GRL	x	x	Horn/Strobe 2W Red Wall 2x4
	P2GWL	x	x	Horn/Strobe 2W WHT Wall 2x4
	P4RL	x	x	Horn/Strobe 4W Red Wall 4X4
	P4WL	x	x	Horn/Strobe 4W WHT Wall 4X4
	PC4RL	x	x	Horn/Strobe 4W Red Ceil 4X4
	PC4WL	x	x	Horn/Strobe 4W WHT Ceil 4X4
	SR		x	Strobe
	SR-P		x	Strobe
	SCR		x	Strobe
	SCR-P		x	Strobe
	SRH		x	Strobe High Candela
	SRH-P		x	Strobe High Candela
	SCRH		x	Strobe High Candela
	SCRH-P		x	Strobe High Candela
	SW		x	Strobe
	SW-P		x	Strobe
	SCW		x	Strobe
	SCW-P		x	Strobe
	SWH		x	Strobe High Candela
	SWH-P		x	Strobe High Candela
	SCWH		x	Strobe High Candela
	SCWH-P		x	Strobe High Candela
	SRK		x	Strobe
	SCRK		x	Strobe
	SRHK		x	Strobe High Candela

Table A-1: Compatible Notification Appliances

Manufacturer	Model	Audio	Visual	Type
System Sensor (cont.)	SCRHK		x	Strobe High Candela
	SRL, SRL-P, SRL-SP*		x	Strobe Red Wall 4x4
	SWL, SWL-P, SWL-ALERT SWL-CLR-ALERT*		x	Strobe White Wall 4x4
	SCRL		x	Strobe Red Ceil 4x4
	SCWL		x	Strobe White Ceil 4x4
	SCWL-CLR-ALERT		x	Strobe WHT Ceil CLR Lens 4x4
	SGRL		x	Strobe Red Wall 2x4
	SGWL		x	Strobe White Wall 2x4
	P2RH-LF	x	x	2-Wire Low Frequency Sounder Strobe
	P2WH-LF	x	x	2-Wire Low Frequency Sounder Strobe
	HR-LF	x		Low Frequency Sounder
	HW-LF	x		Low Frequency Sounder
* P=Plain, ALERT=Pad Printing ALERT, SP=Fuego				
Wheelock	AH-12	x		Horn
	AH-24	x		Horn
	AH-12WP	x		Horn Weatherproof
	AH-24WP	x		Horn Weatherproof
	AMT-241575W	x	x	Multi-Tone Horn Strobe
	AMT-24MCW		x	Multi-Tone Horn Strobe
	AMT-241575W-NYC	x	x	Multi-Tone Horn Strobe
	AMT-12/24	x		Multi-tone Horn
	AMT-12/24 NYC	x		Multi-tone Horn
	AS-121575W		x	Horn/Strobe
	NH-12/24	x	x	Horn
	AS-241575W	x	x	Horn/Strobe
	AS-24MCC	x	x	Horn/Strobe
	AS-24MCCH	x	x	Horn/Strobe
	AS-24MCW	x	x	Horn/Strobe
	AS-24MCWH	x	x	Horn/Strobe
	ASWP-2475W	x	x	Horn/Strobe Weatherproof
	ASWP-2475C	x	x	Horn/Strobe Weatherproof
	ASWP-24MCWH	x	x	Horn/Strobe
	ASWP-24MCCH	x	x	Horn/Strobe
	CH-70	x		Chime
	CH-90	x		Chime
	CH70-241575W		x	Chime/Strobe
	CH70-24MCW		x	Chime/Strobe
	CH70-24MCWH		x	Chime/Strobe
	CH90-24MCC		x	Chime/Strobe
CH90-24MCCH		x	Chime/Strobe	

Table A-1: Compatible Notification Appliances

Manufacturer	Model	Audio	Visual	Type
Wheelock (cont.)	HS-24	x		Horn
	HS4-241575W	x	x	Horn/Strobe
	HS4-24MCW	x	x	Horn/Strobe
	HS4-24MCWH	x	x	Horn/Strobe
	HS4-24MCC	x	x	Horn/Strobe
	MIZ-24S	x	x	Mini Horn Strobe
	MT-121575W		x	MultitoneHorn Strobe
	MT-241575W	x	x	Multitone Horn Strobe
	MT-24MCW		x	Multitone Horn Strobe
	MTWP-2475W		x	Multitone Horn Strobe
	MTWP-2475C		x	Multitone Horn Strobe
	MTG-121575W	x	x	Multitone Horn Strobe
	MTR-121575W	x	x	Multitone Horn Strobe
	MTWPA-2475W	x	x	Multitone Horn Strobe
	MTWPB-2475W	x	x	Multitone Horn Strobe
	MTWPG-2475W	x	x	Multitone Horn Strobe
	MTWPR-2475W	x	x	Multitone Horn Strobe
	MTWPA-24MCCH	x	x	Multitone Horn Strobe
	ZNH	x		Horn
	NS-121575W	x	x	Horn/Strobe
	NS-241575W	x	x	Horn/Strobe
	NS-24MCW	x	x	Horn/Strobe
	NS-24MCC	x	x	Horn/Strobe
	NS-24MCCH	x	x	Horn/Strobe
	ZNS-MCW	x	x	Horn/Strobe
	ZNS-MCWH	x	x	Horn/Strobe
	ZNS-24MCC	x	x	Horn/Strobe
	ZNS-24MCCH	x	x	Horn/Strobe
	RSS-121575W		x	Strobe
	RSS-241575W		x	Strobe
	RSS-24MCC		x	Strobe
	RSS-24MCCR		x	Strobe
	RSS-24MCCH		x	Strobe
	RSS-24MCCHR		x	Strobe
	RSS-24MCW		x	Strobe
	RSS-24MCWH		x	Strobe
	RSSP-121575W		x	Strobe
	RSSP-241575W		x	Strobe
	RSSR-2415W		x	Strobe
	RSSR-2415C		x	Strobe

Table A-1: Compatible Notification Appliances

Manufacturer	Model	Audio	Visual	Type
Wheelock (cont.)	RSSR-2475W		x	Strobe
	RSSR-2475C		x	Strobe
	RSSR-24110C		x	Strobe
	RSSA-24110W		x	Strobe
	RSSB-24110W		x	Strobe
	RSSG-24110W		x	Strobe
	RSSR-24110W		x	Strobe
	RSSA-24MCC		x	Multi-Cd Strobe
	RSSB-24MCC		x	Multi-Cd Strobe
	RSSG-24MCC		x	Multi-Cd Strobe
	RSSR-24MCC		x	Multi-Cd Strobe
	RSSWPA-2475W		x	Strobe Weatherproof
	RSSWPA-24MCCH		x	Strobe Weatherproof
	RSSWPG-24MCCH		x	Strobe Weatherproof
	RSSWPR-24MCCH		x	Strobe Weatherproof
	RSSWP-2475W		x	Strobe Weatherproof
	RSSWP-2475C		x	Strobe Weatherproof
	RSSWP-24MCWH		x	Strobe Weatherproof
	ZRS-MCWH		x	Strobe
	ZRS-24MCC		x	Strobe
	ZRS-24MCCH		x	Strobe
	MB-G6-24	x		Motor Bell
	MB-G10-24	x		Motor Bell
	MB-G6-12	x		Motor Bell
	MB-G10-12	x		Motor Bell
	MIZ-24-R	x		Mini-Horn
	MT-12/24-R	x	x	Multitone Horn
	MT4-12/2z	x	x	Multitone Horn
	ZRS-MCW		x	Strobe
	MTWPR-24MCCH	x	x	Multitone Horn Strobe
	NH-12/24R	x		Horn
	HSR		x	Horn/Strobe
	HSW		x	Horn/Strobe
	STR		x	Strobe
STW		x	Strobe	
HNR		x	Horn	
HNW		x	Horn	

A.2 Smoke Detectors

This section of the manual contains information about smoke detectors that are compatible with the SK-5208.

	SK-5208	SK-5217
Identifier	24J	24J
Maximum Voltage	27.4 VDC	27.4 VDC

Note: The maximum number of smoke detectors per zone is determined by both the current draw and the impedance of the smoke detector. If too many smoke detectors are used on any zone, false alarms could occur.

Do not mix different models of detectors on any zone; false alarms could occur.

Control unit Smoke Reset Time must be programmed for a number greater than or equal to the maximum reset time of the smoke detector.

A.3 Two-Wire Smoke Detectors

The table below lists two-wire smoke detectors that are compatible with the SK-5208 and SK-5217 zone expander. The table is organized by manufacturer. The columns show the number of detectors per loop that can be used.

Manufacturer	Enhanced Mode Compatible	Model Name or Number (Base model name or number in parentheses.)	Compatibility ID		# per Loop
			Head	Base	
Apollo		55000-150, 151, 152, 153	55000-150, 151, 152, 153	45681-200, 220, 230, 231, 232	40
	3	55000-250	55000-350	45681-200, 220, 230, 231, 232	40
	3	55000-350	55000-250	45681-200, 220, 230, 231, 232	25
		55000-380	55000-380	45681-200, 220, 230, 231, 232	15
	3	55000-225	55000-225	45681-255, 256	15 / loop for Ion Detectors
	3	55000-226	55000-226		
	3	55000-227	55000-227	45681-200, 220, 230, 232, 251, 252	15 / loop for Photoelectric detectors
	3	55000-325	55000-325		
	3	55000-328	55000-328		
	3	55000-326	55000-326		
3	55000-327	55000-327			
Detection Systems		DS200 (MB200-2W)	B	A	24
		DS200HD (MB200-2W)	B	A	24
		DS250 (MB2W or MB2WL)	B	A	18
		DS250HD (MB2W or MB2WL)	B	A	18
		DS250TH (MB2W or MB2WL)	B	A	18

Manufacturer	Enhanced Mode Compatible	Model Name or Number (Base model name or number in parentheses.)	Compatibility ID		# per Loop
			Head	Base	
ESL	3	425 (S10)	N/A	S00	30
	3	425C (S10)	N/A	S00	30
	3	425CR (S10)	N/A	S00	30
	3	425CRT (S10)	N/A	S00	30
	3	425CT (S10)	N/A	S00	30
	3	429C (S10A)	N/A	S10A	30
	3	429CRT (S11A)	N/A	S11A	30
	3	429CST (S11A)	N/A	S11A	30
	3	429CT (S10A)	N/A	S10A	30
	3	521B	N/A	S10A/S11A	40
	3	521BXT	N/A	S10A/S11A	40
	3	609U01-11	S10	S00	40
	3	609U02-11	S10	S00/S03	40
	3	611U (601U or 602U)	S10	S00/S03	40
	3	611UD (601U or 602U)	S10	S00/S03	40
	3	611UT (601U or 602U)	S10	S00/S03	40
	ESL	3	612U (601U or 602U)	S10	S00/S03
3		612UD (601U or 602U)	S10	S00/S03	40
3		711U (701E or 701U)	N/A	S10A	25
3		712U (701E or 701U)	N/A	S10A	25
3		713-5U (702E or 701U)	N/A	S10A	25
3		713-6U (702E or 701U)	N/A	S10A	25
FCI	3	721-U (S10A)	N/A	S10A	30
	3	721-UT (S10A)	N/A	S10A	30
		301I (301B)	A	A	20
		301IL (301BL/SS B401BH)	N/A	N/A	20
		301P (301B)	A	N/A	20
		301PL (301BL/SS B401BH)	A	N/A	20
		301PT (301B)	A	N/A	20
		301P (301DH-2)	A	N/A	20
		301I-DH (301DH-2)	A	N/A	20
		2100S	A	N/A	20
		2100TS	A	N/A	20
		2100TR	A	N/A	20
		2100AT	A	N/A	20
		SBS-1101	A	N/A	20
		SBS-1201	A	N/A	20
		SBS-1201T	N/A	N/A	20
		PSD-7155 (2WB/2WRLT/2WRB)	P55FE1	FE51A	40
		PSD-7155 (CPD-001/-002/-003/-005)	P56FE1	FE51A	40
		PSD-7156 (2WB/2WRLT/2WRB)	P55FE1	FE01A	40
	PSD-7156 (CPD-001/-002/-003/-005)	P56FE1	FE01A	40	
	CPD-7051 (2WB/2WRLT/2WRB)	CPD7051	FE51A	40	
	CPD-7051 (CPD-001/-002/-003/-005)	CPD7051	FE51A	40	
	DH100P (Duct Housing)	N/A	N/A	40	

Manufacturer	Enhanced Mode Compatible	Model Name or Number (Base model name or number in parentheses.)	Compatibility ID		# per Loop
			Head	Base	
Grinnell Fire Protection		612H (4B, 6B, 612/912)	612H	4B, 6B, 612/912	15
		612HP (4B, 6B, 612/912)	612HP	4B, 6B, 612/912	15
		612I (4B, 6B, 612/912)	612I 4B	4B, 6B, 612/912	15
		612P (4B, 6B, 612/912)	612P	4B, 6B, 612/912	15
		622HP (4B, 6B, 612/912)	622HP	4B, 6B, 612/912	15
		632H(4B, 6B, 612/912)	632H	4B, 6B, 612/912	15
		MD612 (4B, 6B, 612/912)	MD612	4B, 6B, 612/912	15
		MD622 (4B, 6B, 612/912)	MD622	4B, 6B, 612/912	15
		MD632 (4B, 6B, 612/912)	MD632	4B, 6B, 612/912	15
		MF612 (4B, 6B, 612/912)	MF612	4B, 6B, 612/912	15
		MR612 (4B, 6B, 612/912)	MR612	4B, 6B, 612/912	15
		MR612T (4B, 6B, 612/912)	MR612T	4B, 6B, 612/912	15
		ISC—350I (IBC-350, 351, 353)	ISC—350I	IBC-350, 351, 353	24
	ISC—350P (IBC-350, 351, 353)	ISC—350P	IBC-350, 351, 353	24	
Hochiki		SIH-24F (HS-224D or HSB-224)	N/A	N/A	25
		SLK-12	N/A	N/A	25
		SLK-24F (HS-224D)	N/A	N/A	25
		SLK-24FH (HS-224D)	N/A	N/A	25
		(HS224L) Heat Detector base	N/A	N/A	30
		SLR-8358B	N/A	N/A	25
Kidde-Fenwal		PSD-7155 (70-201000-001)	P55FE1, P56FE1	FE51A, FE01A	40
		PSD-7156 (70-201000-001)	P56FE1	FE01A	40
		CPD-7051 (70-201000-001)	CPD 7051, I51FE1	FE51A, FE01A	40
System Sensor		1100T			20
		1151 (B110LP)			20
		1400	A	N/A	20
		1451 (B401B)	A	A	20
		2100	A	N/A	20
		2100AT	A	N/A	20
		2100D	A	N/A	20
		2100T	A	N/A	20
		2100TR	A	N/A	20
		2100TS	A	N/A	20
		2151 (B401)	A	N/A	16
		2151T (B401)	A	N/A	16
		2151 (B110LP)			20
		2300	A	N/A	20
		2300T	A	N/A	20
		2300TB	A	N/A	20
		2400	A	N/A	20
		2400TH			20
		2400 (DH400)	A	N/A	20
	2451 (B401B)	A	N/A	20	
	2451DH (DH 400)	A	N/A	20	
	2451TH (B401B)	A	N/A	20	

Manufacturer	Enhanced Mode Compatible	Model Name or Number (Base model name or number in parentheses.)	Compatibility ID		# per Loop
			Head	Base	
System Sensor (cont.)		2W-B	A	N/N	25
		2WT-B	A	N/A	25
		2WTR-B	A	N/A	25

A.4 Four Wire Smoke Detectors

Manufacturer	Model
Hochiki	SLR-835B with HD-6 Base
ESL	445C Series 449C Series
System Sensor	1851B 2851/2851BTH DH400AC/DC

Honeywell Fire Product Warranty and Return Policy

General Terms and Conditions

- All new fire products manufactured by Honeywell Silent Knight have a limited warranty period of 36 months from the date of manufacture against defects in materials and workmanship. See limited warranty statement for details.
- This limited warranty does not apply to those products that are damaged due to misuse, abuse, negligence, exposure to adverse environmental conditions, or have been modified in any manner whatsoever.

Repair and RMA Procedure

- All products that are returned to Honeywell for credit or repair require a RMA (Return Authorization) number. Call Customer Service at 800-328-0103 or 203-484-7161 between 8:00 A.M. and 5:00 P.M. EST, Monday through Friday to obtain a return authorization number.
- Honeywell Silent Knight and Farenhyt Series Technical Support is available at 800-446-6444 between 8:00 A.M. and 5:00 P.M. CST, Monday through Friday.
- All returns for credit are subject to inspection and testing at the factory before actual determination is made to allow credit.
- RMA number must be prominently displayed on the outside of the shipping box. See return address example under Advanced Replacement Policy.
- Included with each return should be: a packing slip that has the RMA number, a content list, and a detailed description of the problem.
- All products returned by Honeywell must be sent freight pre-paid. After the product is processed, Honeywell will pay for shipping product back to customer via UPS ground.
- Return the Honeywell Silent Knight product circuit board only. Products that are returned in cabinets will be charged an additional \$50 to cover the extra shipping and handling costs over board only returns. **Do not return batteries.** Honeywell has the authority to determine if a product is repairable. Products that are deemed un-repairable will be returned to the customer.
- Product that is returned that has a board date code more than 36 months from date of manufacture will be repaired and the customer will be assessed the standard Honeywell Silent Knight repair charge for that model.

Advanced Replacement Policy

- Honeywell Silent Knight and Farenhyt Series offers an option of advance replacement for fire product printed circuit boards that fail during the first 6 months of the warranty period. These items must be returned with transportation charges prepaid and must be accompanied by a return authorization.
- For advance replacement of a defective board, contact your local Honeywell Silent Knight distributor or call Honeywell Silent Knight at 800-328-0103 to obtain a RMA (Return Authorization) number and request advanced replacement.
- A new or refurbished board will be shipped to the customer. The customer will initially be billed for the replacement board but a credit will be issued after the repairable board is received at Honeywell Silent Knight. All returned products must comply with the guidelines described under “General Terms and Conditions” and “Repair and RMA Procedure”.
- The defective board must be returned within 30 days of shipment of replacement board for customer to receive credit. No credit will be issued if the returned board was damaged due to misuse or abuse.

- Repairs and returns should be sent to:
Honeywell Fire Systems
Attn: Repair Department / RA Number _____
12 Clintonville Road
Northford, CT 06472 USA

Manufacturer Warranties and Limitation of Liability

Manufacturer Warranties. Subject to the limitations set forth herein, Manufacturer warrants that the Products manufactured by it in its Northford, Connecticut facility and sold by it to its authorized Distributors shall be free, under normal use and service, from defects in material and workmanship for a period of thirty six months (36) months from the date of manufacture (effective Jan. 1, 2009). The Products manufactured and sold by Manufacturer are date stamped at the time of production. Manufacturer does not warrant Products that are not manufactured by it in its Northford, Connecticut facility but assigns to its Distributor, to extent possible, any warranty offered by the manufacturer of such product. This warranty shall be void if a Product is altered, service repaired by anyone other than Manufacturer or its authorized Distributors. This warranty shall also be void if there is a failure to maintain the Products and the systems in which they operate in proper working conditions.

MANUFACTURER MAKES NO FURTHER WARRANTIES, AND DISCLAIMS ANY AND ALL OTHER WARRANTIES, EITHER EXPRESSED OR IMPLIED, WITH RESPECT TO THE PRODUCTS, TRADEMARKS, PROGRAMS AND SERVICES RENDERED BY MANUFACTURER INCLUDING WITHOUT LIMITATION, INFRINGEMENT, TITLE, MERCHANTABILITY, OR FITNESS FOR ANY PARTICULAR PURPOSE. MANUFACTURER SHALL NOT BE LIABLE FOR ANY PERSONAL INJURY OR DEATH WHICH MAY ARISE IN THE COURSE OF, OR AS A RESULT OF, PERSONAL, COMMERCIAL OR INDUSTRIAL USES OF ITS PRODUCTS.

This document constitutes the only warranty made by Manufacturer with respect to its products and replaces all previous warranties and is the only warranty made by Manufacturer. No increase or alteration, written or verbal, of the obligation of this warranty is authorized. Manufacturer does not represent that its products will prevent any loss by fire or otherwise.

Warranty Claims. Manufacturer shall replace or repair, at Manufacturer's discretion, each part returned by its authorized Distributor and acknowledged by Manufacturer to be defective, provided that such part shall have been returned to Manufacturer with all charges prepaid and the authorized Distributor has completed Manufacturer's Return Material Authorization form. The replacement part shall come from Manufacturer's stock and may be new or refurbished. THE FOREGOING IS DISTRIBUTOR'S SOLE AND EXCLUSIVE REMEDY IN THE EVENT OF A WARRANTY CLAIM.

Warn-HL-08-2009.fm



SILENT KNIGHT

by Honeywell

Model SK5208 Basic Operating Instructions

These Instructions must be framed and displayed next to the SK-5208 panel in accordance with NFPA 72 fire code for Local Protected Fire Alarm Systems.

Cut Along the Dotted Line

Operation	Task to Perform
Test the system	Press 0 ENTER then enter a code if prompted. The system will perform a display lamp test and a communication test. Displays Firmware Revisions.
Reset Alarms	Press 1 ENTER or RESET then enter a code if prompted.
Reset the Dialer	Press 3 ENTER, then enter a code if prompted. Resets the dialer and aborts the call to central station.
Display History Events	Press 5 ENTER then enter a code if prompted. Displays the panel history, which includes alarms, supervisories, troubles, reports, time and date changes, etc.
Show Status	Press 6 ENTER then enter a code if prompted. View existing system status. List Alarms first, supervisories and then troubles.
Silence Troubles or Alarms	Press 7 ENTER or SILENCE then enter a code if prompted. Silence LED will light.
Disable/Enable a Zone	1. Press Zone # + * 2. Enter Code. Repeat the process to enable the zone.
Disable/Enable NAC	1. Press 1 0 NAC # + * 2. Enter Code. Repeat the process to enable the NAC.
Conduct a Fire Drill	1. Press 2 0 ENTER then enter a code 2. Press RESET then code to end the drill.
Reset Detectors	1. Press 2 1 ENTER then enter a code. Resets all smoke detector power.
Walk Test the System	1. Press 2 2 ENTER then enter a code 2. Press RESET to end the Walk Test.
Acknowledge Events	Events can be acknowledged by pressing the ENTER button. No code is required to acknowledge events. The status LEDs (Alarm, Supervisory and Trouble) will flash when an un-acknowledged alarm, supervisory, or trouble condition exists. After each event has been acknowledged its associated LED (Alarm, Supervisory, or Trouble LED) stop flashing and turn on steady. When viewing system status the LCD displays "Aked" for each individual event once it has been acknowledged. The control panel piezo will silence after all alarms have been acknowledged. Note: The control panel piezo will continue to sound for Supervisories and Troubles even after the event has been acknowledged. Supervisories and troubles will silence once the event is restored. After the event is acknowledged an event is added to the event history buffer. Acknowledged events in the history buffer will be preceded with an asterisk "**".

LED Meanings

LED	Status	Condition
ALARM (red)	Off	Normal condition
	On	System in alarm.
	Flashing	LED will flash when a alarm condition exists that has not been acknowledged.
SUPERVISORY (yellow)	Off	Normal condition
	On	If a supervisory condition exist on the system.
	Flashing	LED will flash when a supervisory condition exists that has not been acknowledged.
TROUBLE (yellow)	Off	Normal condition
	On	Trouble condition exists
	Flashing	LED will flash when a trouble condition exists that has not been acknowledged.
SILENCED (yellow)	Off	Normal condition.
	On	Alarm or trouble condition has been silenced but condition still exists.
AC (green)	On	Panel is running on AC (normal condition); standby battery fully charged.
	Off	Panel has lost all power.
	Flashing	Panel is running on battery power only or AC power only.



**SILENT
KNIGHT**

by Honeywell

Silent Knight
12 Clintonville Road
Northford, CT 06472-1610
203-484-7161
Fax: 203-484-7118

www.silentknight.com